



PS

WE INTRODUCE OURSELVES

Since the company was founded in 2005, we develop and sell floor sockets, retractable supply posts, wall distributors and energy columns for indoor and outdoor use. The priorities are in quality, design and the best price-performance ratio.

In addition to our extensive standard program, we also offer individual processing and custom-made products. Our diverse range of services ensures that your requirements are implemented quickly and efficiently.

The fact that our products are made and manufactured exclusively in Germany can be seen from the elegant design, the high-quality material and the sophisticated workmanship. Robust, tough and weatherproof for outdoors, or discreet and adapted for indoors, our products are always practical and useful.

We only use VDE-certified sockets inserts for our products, which you can also obtain from us according to French, Danish, Belgian or Swiss standards.

WITH US, YOU WILL BENEFIT

- With only one order number: One order number for a complete product.
- With ready-to-install products: You receive completely ready-to-install products, whereby the individual parts do not first have to be put together and laboriously assembled.
- With extensive stock goods: Many of our products are already prefabricated and can be delivered within a very short time.
- With a short response time: Ordered goods usually leave the factory on the same day, so that a large part of our deliveries arrive the next day.
- With creative special solutions: you can't find a suitable product that exactly matches your ideas? Let us know your requirements and we will develop affordable special solutions exactly according to your wishes.

CONTACT

Vander Elst
Oostvaardijk 42
1850 Grimbergen
Tel: +32 2 242 79 59
BTWBE 0421678794
info@vanderelst.be
www.vanderelst.be

NOTE ON THE CONTENT OF THE CATALOG

The IP protection class applies to all products when closed and when installed correctly. Subject to errors and technical changes.

The illustrations in the catalog were created graphically. The equipment shown in the pictures is similar to the written description.

CONTENTS

Floor sockets/tanks Indoor	5-31
Floor sockets outdoor	33-39
Raised access floor boxes/tanks	41-49
CEE-floor tanks	51-57
Retractable power distributors	59-62
Power columns	63-70
Ground anchors	71-76
Wall distributors	77-84
Desk power strips	85-87
General terms and conditions	88-91
Model withdrawal form	92
Product finder/Index	93



floor socket /-tanks
→ Indoor



Color DB703

1206

Item No.:	Equipment:
1206-1	4 x socket, 2 x RJ45 double (supply line below)
1206-2	4 x socket, 2 x USB charge A/C double (supply line below)
1206-3	4 x socket, 1 x RJ45 double (supply line back)
1206-4	4 x socket, 1 x USB charge A/C double (supply line back)

Material:	Aluminum
Dimensions:	142 x 90 x 142 mm (W x H x D)
Protection:	IP20
Load:	Area load max. 120kg
Supply line:	Opening from below → 40,7 x 40,7 mm
Color:	DB701, DB703, white (RAL9010), black (RAL9005)
Feature:	The on-floor tank is versatile, can also be mounted on work surfaces and under cupboards/shelves.



2003A

Item No.:	Equipment:
2003A	3 x socket
2003A1	2 x socket, 1 x RJ45 double

Opt. parts: 12185 screed placeholder made of EPS (on demand)

Material:	Stainless steel (1.4301), Aluminum
Dimensions:	199 x 82 x 199 mm (W x H x D)
Instl depth:	82 mm (floor)
Protection:	IP65
Load:	Area load max. 900 kg
Supply line:	2 x back, each Ø 25 mm
Feature:	Lockable with tools. With cable protection.

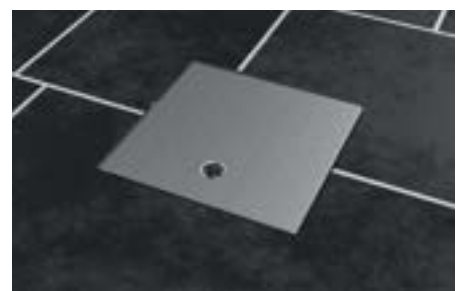



2003B

Item No.:	Equipment:
2003B	3 x socket
2003B1	2 x socket, 1 x RJ45 double

Opt. parts: 12185 screed placeholder made of EPS (on demand)

Material:	Stainless steel (1.4301), Aluminum
Dimensions:	199 x 91 x 199 mm (W x H x D)
Instl depth:	91 mm (floor)
Protection:	IP65
Load:	Area load max. 200 kg
Supply line:	2 x back, each Ø 25 mm
flooring insert:	15 mm
Feature:	Lockable without tools, flooring can be integrated. With cable protection.

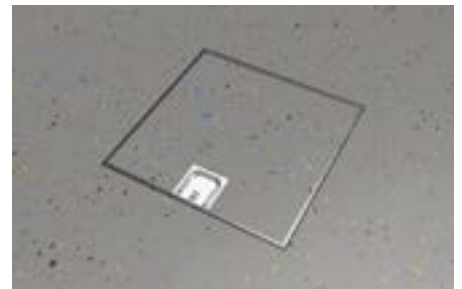

2003Q

Item No.:	Equipment:
2003Q	3 x socket
2003Q1	2 x socket, 1 x RJ45 double

Opt. parts: 12185 screed placeholder made of EPS (on demand)

Material:	Stainless steel (1.4301), Aluminum
Dimensions:	199 x 82 x 199 mm (W x H x D)
Instl depth:	82 mm (floor)
Protection:	IP65/IP21 with attached tube
Load:	Area load max. 900 kg
Supply line:	2 x back, each Ø 25 mm
Feature:	Lockable with a tool, with internal tube for using the tank with the lid closed.





2004A

Item No.:	Equipment:
2004A	4 x socket
2004A1	3 x socket, 1 x RJ45 double

Opt. parts: 12185 screed placeholder made of EPS (on demand)

Material:	Stainless steel (1.4301), Aluminum
Dimensions:	250 x 82 x 250 mm (W x H x D)
Instl depth:	82 mm (floor)
Protection:	IP65
Load:	Area load max. 900 kg
Supply line:	4 x back, each Ø 25 mm
Feature:	Lockable with tools. With cable protection.

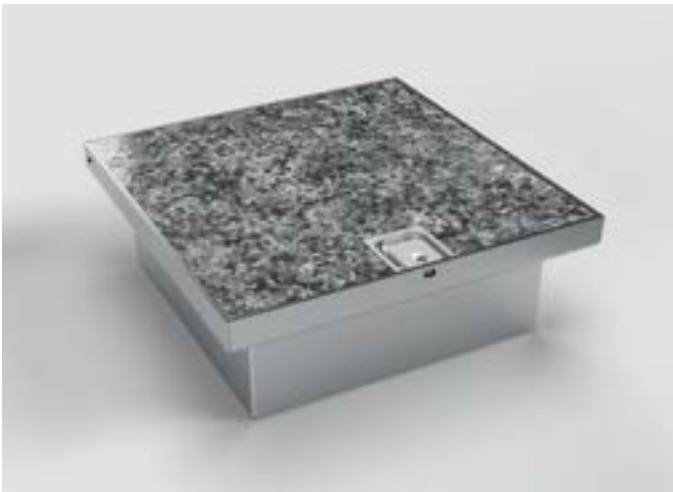

2004B

Item No.:	Equipment:
2004B	4 x socket
2004B1	3 x socket, 1 x RJ45 double

Opt. parts: 12185 screed placeholder made of EPS (on demand)

Material:	Stainless steel (1.4301), Aluminum
Dimensions:	250 x 91 x 250 mm (W x H x D)
Instl depth:	91 mm (floor)
Protection:	IP65
Load:	Area load max. 200 kg
Supply line:	4 x back, each Ø 25 mm
flooring insert:	15 mm
Feature:	Lockable without tools, flooring can be integrated. With cable protection.

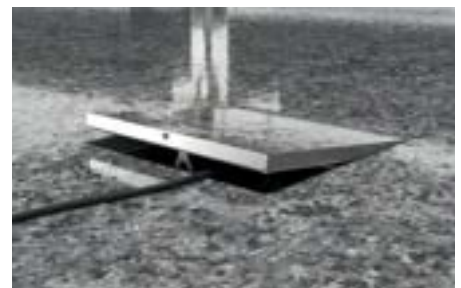



2004Q

Item No.:	Equipment:
2004Q	4 x socket
2004Q1	3 x socket, 1 x RJ45 double

Opt. parts: 12185 screed placeholder made of EPS (on demand)

Material:	Stainless steel (1.4301), Aluminum
Dimensions:	250 x 82 x 250 mm (W x H x D)
Instl depth:	82 mm (floor)
Protection:	IP65/IP21 with attached tube
Load:	Area load max. 900 kg
Supply line:	4 x back, each Ø 25 mm
Feature:	Lockable with a tool, with internal tube for using the tank with the lid closed.

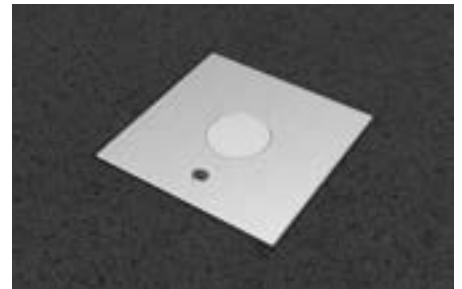
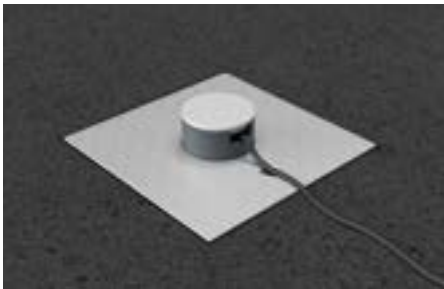

2008A

Item No.:	Equipment:
2008A	8 x socket
2008A1	4 x socket, 4 x RJ45 double

Opt. parts: 12185 screed placeholder made of EPS (on demand)

Material:	Stainless steel (1.4301), Aluminum
Dimensions:	250 x 82 x 250 mm (W x H x D)
Instl depth:	82 mm (floor)
Protection:	IP65
Load:	Area load max. 900 kg
Supply line:	8 x lateral, each Ø 25 mm
Feature:	Lockable with tools. With cable protection.



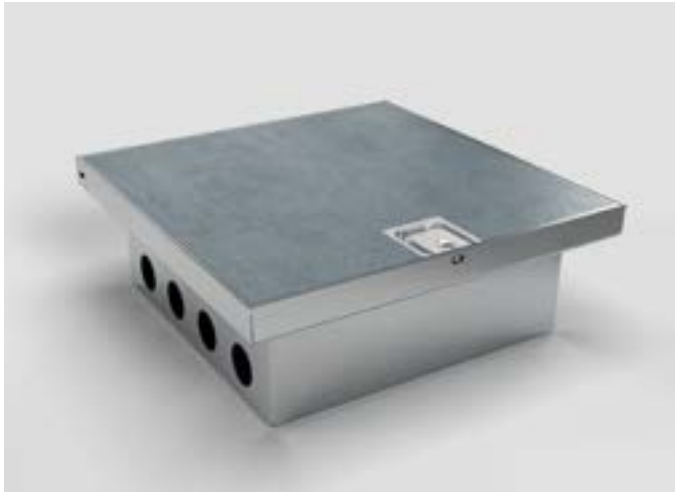

2008B

Item No.:	Equipment:
2008B	8x socket
2008B1	4x socket, 4x RJ45 double

Opt. parts: 12185 screed placeholder made of EPS (on demand)

Material: Stainless steel (1.4301), Aluminum

Dimensions: 250x91x250 mm (WxHxD)

Instl depth: 91 mm (floor)

Protection: IP65

Load: Area load max. 200 kg

Supply line: 8x lateral, each Ø 25 mm

flooring insert: 15 mm

Feature: Lockable without tools, flooring can be integrated. With cable protection.



2008Q

Item No.:	Equipment:
2008Q	8x socket
2008Q1	4x socket, 4x RJ45 double

Opt. parts: 12185 screed placeholder made of EPS (on demand)

Material: Stainless steel (1.4301), Aluminum

Dimensions: 250x82x250 mm (WxHxD)

Instl depth: 82 mm (floor)

Protection: IP65/IP21 with attached tube

Load: Area load max. 900 kg

Supply line: 8x lateral, each Ø 25 mm

Feature: Lockable with a tool, with internal tube for using the tank with the lid closed.

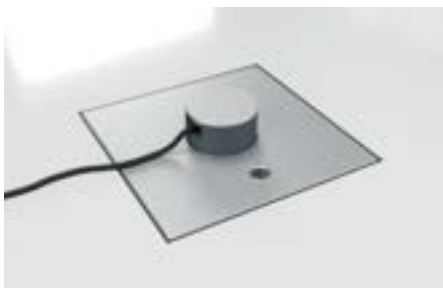



3202E

Item No.:	Equipment:
3202E	2 x socket (incl. box)
3202E1	1 x socket, 1 x RJ45 double (incl. box)
3202E2	1 x socket, 1 x aerial (incl. box)

Material:	Stainless steel (1.4301)
Dimensions:	180 x 83 x 154 mm (W x H x D)
Instl depth:	81,5 mm (floor)
Protection:	IP20
Load:	Area load max. 120 kg
Supply line:	2 x lateral, 2 x back, 2 x below; each Ø 26 mm



3203E

Item No.:	Equipment:
3203E	3 x socket (incl. box)
3203E1	2 x socket, 1 x RJ45 double (incl. box)
3203E2	2 x socket, 1 x aerial (incl. box)

Material:	Stainless steel (1.4301)
Dimensions:	230 x 83 x 153 mm (W x H x D)
Instl depth:	81,5 mm (floor)
Protection:	IP20
Load:	Area load max. 120 kg
Supply line:	2 x lateral, 2 x back, 2 x below; each Ø 26 mm





3301E

Item No.:	Equipment:
3301E	1 x socket (incl. box)
3301E1	1 x socket, 2 x RJ45 single (incl. box)

Opt. parts: 12184 screed placeholder made of EPS (on demand)

Material:	Stainless steel (1.4301)
Dimensions:	110 x 62 x 110 mm (W x H x D)
Instl depth:	60 mm (floor)
Protection:	IP20
Load:	Area load max. 120 kg
Supply line:	1 x front, 1 x back, 2 x below, each \varnothing 26 mm



3302E

Item No.:	Equipment:
3302E	2 x socket (incl. box)
3302E1	1 x socket, 1 x RJ45 double (incl. box)
3302E2	1 x socket, 1 x aerial (incl. box)

Opt. parts: 12184 screed placeholder made of EPS (on demand)

Material:	Stainless steel (1.4301)
Dimensions:	160 x 62 x 110 mm (W x H x D)
Instl depth:	60 mm (floor)
Protection:	IP20
Load:	Area load max. 120 kg
Supply line:	2 x front, 2 x back, 2 x below, each \varnothing 26 mm





3303E

Item No.:	Equipment:
3303E	3 x socket (incl. box)
3303E1	2 x socket, 1 x RJ45 double (incl. box)
3303E2	2 x socket, 1 x aerial (incl. box)
<hr/>	
Material:	Stainless steel (1.4301)
Dimensions:	220x62x110 mm (WxHxD)
Instl depth:	60 mm (floor)
Protection:	IP20
Load:	Area load max. 120kg
Supply line:	2 x front, 2 x back, 2 x below, each Ø 26 mm

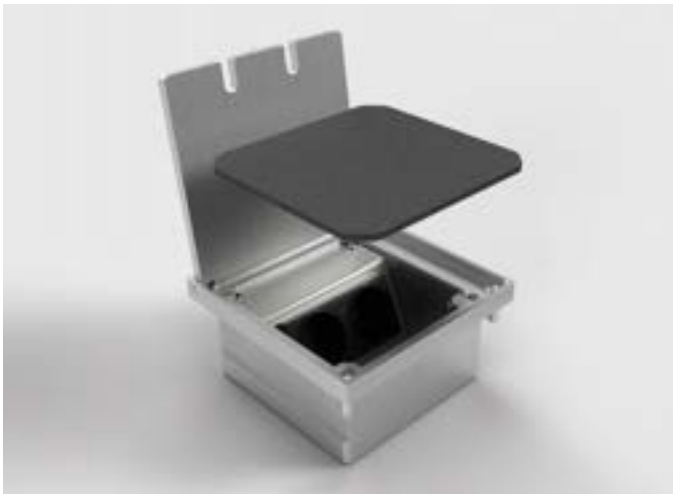

8302A

Item No.:	Equipment:
8302A	2 x socket
8302A1	1 x socket, 1 x RJ45 double
8302A2	1 x socket, 1 x aerial
<hr/>	
Opt. parts:	12184 screed placeholder made of EPS (on demand)
<hr/>	
Material:	Aluminum
Dimensions:	150x77x150 mm (WxHxD)
Instl depth:	77 mm (floor)
Protection:	IP64
Load:	Area load max. 900 kg
Supply line:	2 x back, each Ø 25 mm
Feature:	Lockable without tools, can be closed with inserted plugs.

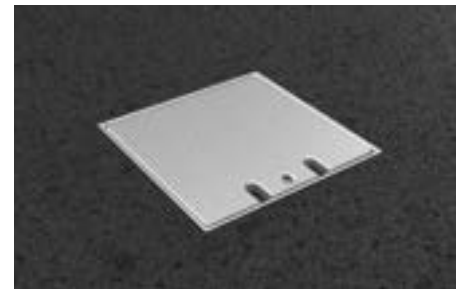



8308A

Item No.:	Equipment:
8308A	8x socket
8308A1	4x socket, 4x RJ45 double

Opt. parts: 12185 screed placeholder made of EPS (on demand)

Material:	Aluminum, Stainless steel
Dimensions:	250 x 131 x 160 mm (W x H x D)
Instl depth:	131 mm (floor)
Protection:	IP65
Load:	Area load max. 500 kg
Supply line:	4x back, each Ø 25 mm
Feature:	Lockable without tools. With cable protection.



8601A

Item No.:	Equipment:
8601A	1x socket
8601A1	1x socket, 1x RJ45 single

Opt. parts: 12102 screed placeholder made of EPS (on demand)

Material:	Aluminum
Dimensions:	Rim Ø 140 mm, Ø 120 x 64 mm
Instl depth:	62 mm (floor)
Protection:	IP65
Load:	Area load max. 900 kg
Supply line:	2x below, each Ø 25 mm
Feature:	Lockable without tools.





8602A

Item No.:	Equipment:
8602A	2 x socket
8602A2	2 x socket, 2 x RJ45 single

Opt. parts: 12104 screed placeholder made of EPS (on demand)

Material:	Aluminum
Dimensions:	Rim \varnothing 149 mm, \varnothing 130 x 70 mm
Instl depth:	68 mm (floor)
Protection:	IP65
Load:	Area load max. 900 kg
Supply line:	2 x back, 2 x below, each \varnothing 25 mm
Feature:	Lockable without tools.



8604A

Item No.:	Equipment:
8604A	4 x socket
8604A1	3 x socket, 1 x RJ45 double

Opt. parts: 12106 screed placeholder made of EPS (on demand)

Material:	Aluminum, Stainless steel
Dimensions:	Rim \varnothing 218 mm, \varnothing 204 x 80 mm
Instl depth:	77 mm (floor)
Protection:	IP65
Load:	Area load max. 900 kg
Supply line:	4 x lateral, 4 x below, each \varnothing 25 mm
Feature:	Lockable without tools.





8701A

Item No.:	Equipment:
8701A	1 x socket
8701A1	1 x RJ45 double

Opt. parts: 12184 screed placeholder made of EPS (on demand)

Material:	Aluminum
Dimensions:	100x70x100 mm (WxHxD)
Instl depth:	70 mm (floor)
Protection:	IP65
Load:	Area load max. 900 kg
Supply line:	1 x front, 1 x back, each M25 x 1,5 mm
Feature:	Lockable without tools.

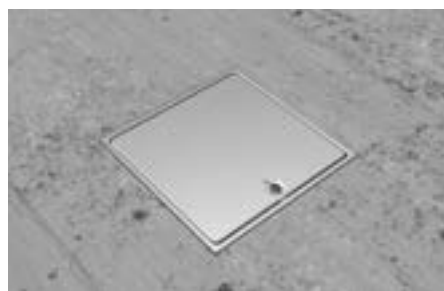

8702A

Item No.:	Equipment:
8702A	2 x socket
8702A1	1 x socket, 1 x RJ45 double

Opt. parts: 12184 screed placeholder made of EPS (on demand)

Material:	Aluminum
Dimensions:	120x70x120 mm (WxHxD)
Instl depth:	70 mm (floor)
Protection:	IP65
Load:	Area load max. 900 kg
Supply line:	2 x back, each M25 x 1,5 mm
Feature:	Lockable without tools.

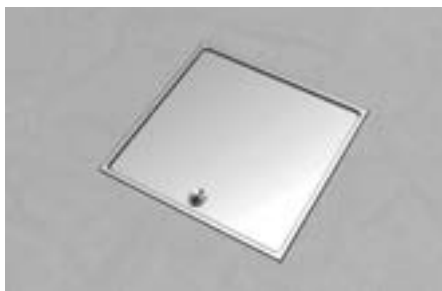



8802A

Item No.:	Equipment:
8802A	2 x socket
8802A1	1 x socket, 1 x RJ45 double
8802A2	1 x socket, 1 x aerial

Opt. parts: 12184 screed placeholder made of EPS (on demand)

Material:	Aluminum
Dimensions:	125 x 72 x 125 mm (W x H x D)
Instl depth:	72 mm (floor)
Protection:	IP20
Load:	Area load max. 900 kg
Supply line:	2 x back, each Ø 25 mm
Leveling:	5 mm
Feature:	Can be closed with inserted plugs.



8802B

Item No.:	Equipment:
8802B	2 x socket
8802B1	1 x socket, 1 x RJ45 double
8802B2	1 x socket, 1 x aerial

Opt. parts: 12184 screed placeholder made of EPS (on demand)

Material:	Aluminum, stainless steel
Dimensions:	125 x 67 x 125 mm (W x H x D)
Instl depth:	67 mm (floor)
Protection:	IP20
Load:	Area load max. 300 kg
Supply line:	2 x back, each Ø 25 mm
Leveling:	5 mm
Feature:	Rimless lid for sticking your own coverings, can be closed with inserted plugs.





8802E

Item No.:	Equipment:
8802E	2x socket
8802E1	1 x socket, 1 x RJ45 double
8802E2	1 x socket, 1 x aerial

Opt. parts: 12184 screed placeholder made of EPS (on demand)

Material:	Aluminum, stainless steel
Dimensions:	125 x 69 x 125 mm (W x H x D)
Instl depth:	69 mm (floor)
Protection:	IP20
Load:	Area load max. 400 kg
Supply line:	2x back, each Ø 25 mm
Leveling:	5 mm
Feature:	Can be closed with inserted plugs.

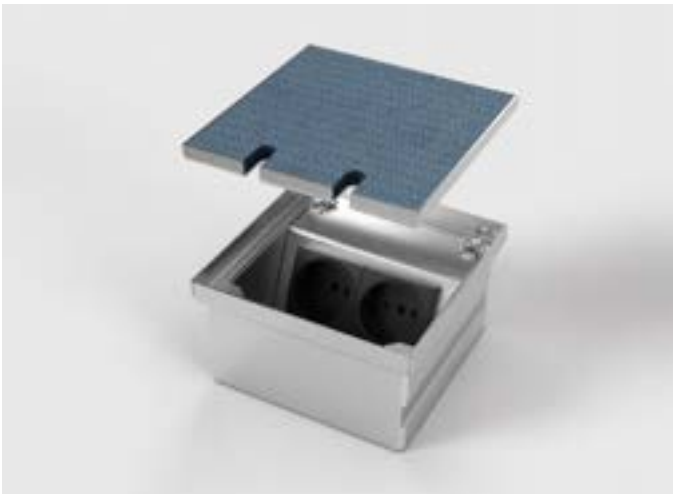
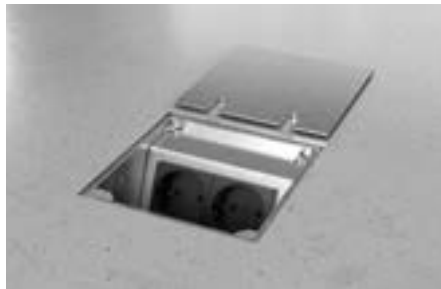
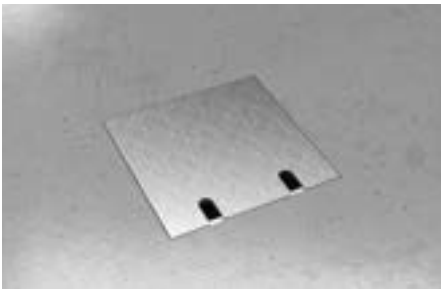

8802T

Item No.:	Equipment:
8802T	2x socket
8802T1	1 x socket, 1 x RJ45 double
8802T2	1 x socket, 1 x aerial

Opt. parts: 12184 screed placeholder made of EPS (on demand)

Material:	Aluminum, Stainless steel
Dimensions:	135 x 75 x 135 mm (W x H x D)
Instl depth:	75 mm (floor)
Protection:	IP20
Load:	Area load max. 200 kg
Supply line:	2x back, each Ø 25 mm
Flooring insert:	6,5 mm
Feature:	Flooring can be integrated, closeable with inserted plugs.

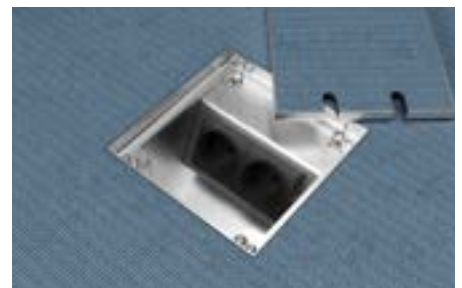
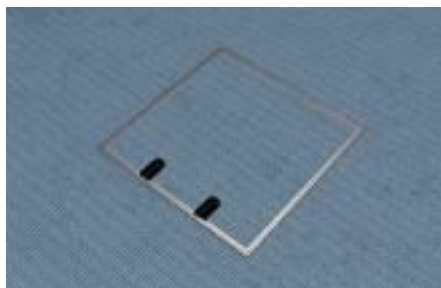



8804B

Item No.:	Equipment:
8804B	4 x socket
8804B1	3 x socket, 1 x RJ45 double
8804B2	3 x socket, 1 x aerial
8804B3	2 x socket, 1 x RJ45 double, 1 x aerial

Opt. parts: 12111 screed placeholder made of EPS (on demand)

Material:	Aluminum, Stainless steel
Dimensions:	220 x 68 x 150 mm (W x H x D)
Instl depth:	68 mm (floor)
Protection:	IP20
Load:	Area load max. 200 kg
Supply line:	4 x back, each Ø 25 mm
Leveling:	5 mm
Feature:	Rimless lid for sticking your own coverings, can be closed with inserted plugs.



8804E

Item No.:	Equipment:
8804E	4 x socket
8804E1	3 x socket, 1 x RJ45 double
8804E2	3 x socket, 1 x aerial
8804E3	2 x socket, 1 x RJ45 double, 1 x aerial

Opt. parts: 12111 screed placeholder made of EPS (on demand)

Material:	Aluminum, Stainless steel
Dimensions:	220 x 70 x 150 mm (W x H x D)
Instl depth:	70 mm (floor)
Protection:	IP20
Load:	Area load max. 300 kg
Supply line:	4 x back, each Ø 25 mm
Leveling:	5 mm
Feature:	Can be closed with inserted plugs.

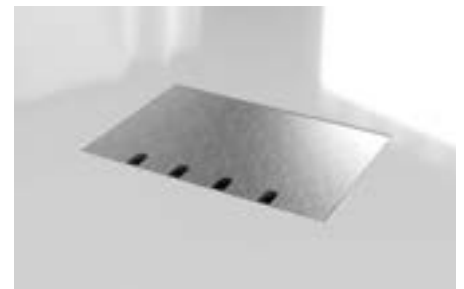



8804T

Item No.:	Equipment:
8804T	4 x socket
8804T1	3 x socket, 1 x RJ45 double
8804T2	3 x socket, 1 x aerial
8804T3	2 x socket, 1 x RJ45 double, 1 x aerial

Opt. parts: 12111 screed placeholder made of EPS (on demand)

Material:	Aluminum, stainless steel
Dimensions:	240 x 74 x 160 mm (W x H x D)
Instl depth:	74 mm (floor)
Protection:	IP20
Load:	Area load max. 200 kg
Supply line:	4 x back, each Ø 25 mm
Flooring insert:	6,5 mm
Feature:	Covering can be integrated, ideal for carpets, can be closed with inserted plugs.

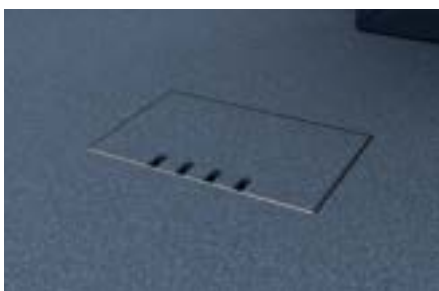

8808A

Item No.:	Equipment:
8808A	8 x socket
8808A1	4 x socket, 4 x RJ45 double

Opt. parts: 12185 screed placeholder made of EPS (on demand)

Material:	Aluminum, stainless steel
Dimensions:	240 x 61 x 240 mm (W x H x D)
Instl depth:	61 mm (floor)
Protection:	IP20
Load:	Area load max. 200 kg
Supply line:	4 x front, 4 x back, each Ø 25 mm
Leveling:	5 mm
Feature:	Can be closed with inserted plugs.

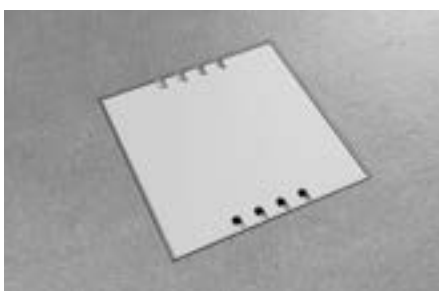
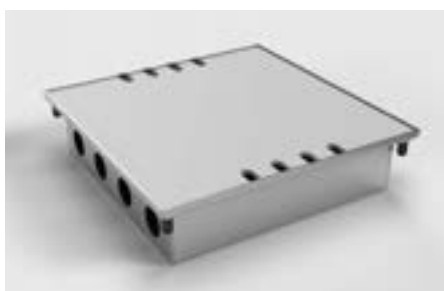



8808B

Item No.:	Equipment:
8808B	8 x socket
8808B1	4 x socket, 4 x RJ45 double

Opt. parts: 12185 screed placeholder made of EPS (on demand)

Material:	Aluminum, stainless steel
Dimensions:	240 x 61 x 240 mm (W x H x D)
Instl depth:	61 mm (floor)
Protection:	IP20
Load:	Area load max. 200 kg
Supply line:	4 x front, 4 x back, each \varnothing 25 mm
Leveling:	5 mm
Feature:	Rimless lid for sticking your own coverings, can be closed with inserted plugs.

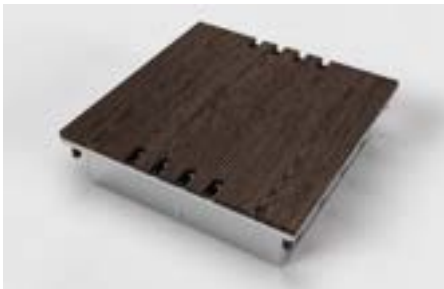

8808E

Item No.:	Equipment:
8808E	8 x socket
8808E1	4 x socket, 4 x RJ45 double

Opt. parts: 12185 screed placeholder made of EPS (on demand)

Material:	Aluminum, stainless steel
Dimensions:	240 x 61 x 240 mm (W x H x D)
Instl depth:	61 mm (floor)
Protection:	IP20
Load:	Area load max. 200 kg
Supply line:	4 x front, 4 x back, each \varnothing 25 mm
Leveling:	5 mm
Feature:	Can be closed with inserted plugs.

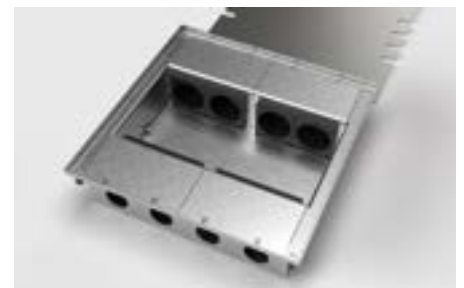
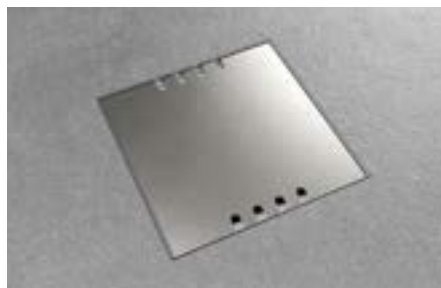

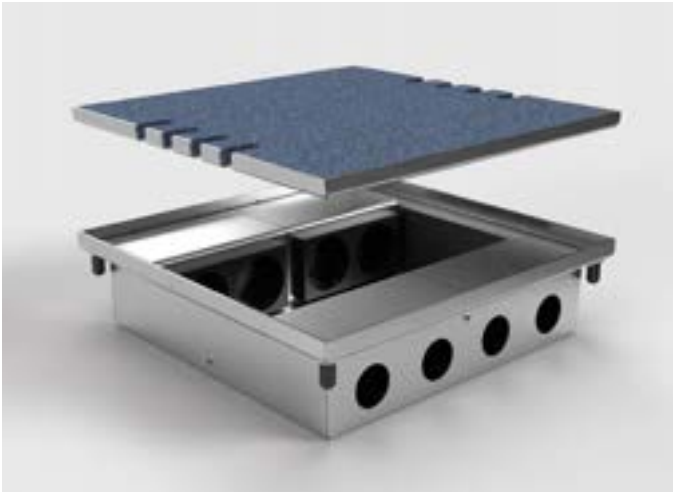

8808T

Item No.:	Equipment:
8808T	8x socket
8808T1	4x socket, 4x RJ45 double

Opt. parts: 12185 screed placeholder made of EPS (on demand)

Material:	Aluminum, stainless steel
Dimensions:	240 x 65 x 240 mm (W x H x D)
Instl depth:	65 mm (floor)
Protection:	IP20
Load:	Area load max. 120 kg
Supply line:	4x front, 4x back, each Ø 25 mm
Flooring insert:	6,5 mm
Feature:	Covering can be integrated, ideal for carpets, can be closed with inserted plugs.

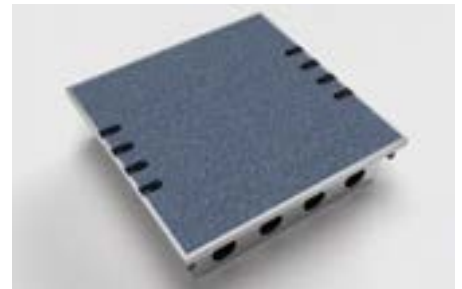

8810B

Item No.:	Equipment:
8810B	10x socket
8810B1	5x socket, 5x RJ45 double

Material:	Aluminum, stainless steel
Dimensions:	300 x 61 x 300 mm (W x H x D)
Instl depth:	61 mm (floor)
Protection:	IP20
Load:	Area load max. 200 kg
Supply line:	5x front, 5x back, each Ø 25 mm
Leveling:	5 mm
Feature:	Rimless lid for sticking your own coverings, can be closed with inserted plugs.





8900B

Item No.: 8900B	Equipment: 1 x socket
Material:	Stainless steel, aluminum
Dimensions:	76 x 80 x 78 mm (W x H x D)
Instl depth:	80 mm (floor)
Protection:	IP30
Load:	Area load max. 120 kg
Supply line:	2 x lateral, 2 x below, each Ø 26 mm
Leveling:	30 mm
Flooring insert:	15 mm
Feature:	Covering can be integrated, with magnets in the lid for easy opening of the sockets.



8901B

Item No.: 8901B 8901B1 8901B2	Equipment: 1 x socket 1 x RJ45 double 1 x aerial
Opt. parts:	12201 leveling set for height correction (page 27)
Material:	Stainless steel, aluminum
Dimensions:	125 x 90–120 x 125 mm (W x H x D)
Instl depth:	90–120 mm (floor)
Protection:	IP20
Load:	Area load max. 120 kg
Supply line:	2 x lateral, 2 x back, 2 x below, each Ø 26 mm
Leveling:	30 mm
Flooring insert:	15 mm
Feature:	Covering can be integrated, can be closed with inserted plugs.

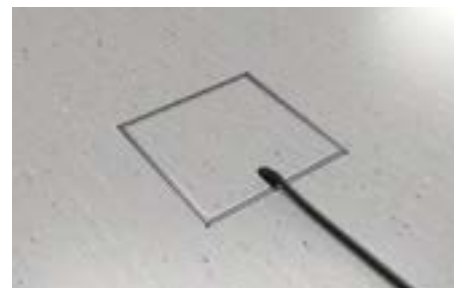



8902B

Item No.:	Equipment:
8902B	2 x socket
8902B1	1 x socket, 1 x RJ45 double
8902B2	1 x socket, 1 x aerial
8902B3	2 x socket, 2 x RJ45 single

Opt. parts: 12201 leveling set for height correction (page 27)

Material:	Stainless steel, aluminum
Dimensions:	155x90-120x155 mm (W x H x D)
Instl depth:	90-120 mm (floor)
Protection:	IP20
Load:	Area load max. 120 kg
Supply line:	2 x lateral, 3 x back, 3 x below, each \varnothing 26 mm
Leveling:	30 mm
Flooring insert:	15 mm
Feature:	Can be closed with inserted plugs.



8902BB

Item No.:	Equipment:
8902BB	2 x socket
8902BB1	1 x socket, 1 x RJ45 double
8902BB2	1 x socket, 1 x aerial
8902BB3	2 x socket, 2 x RJ45 single

Opt. parts: 12201 leveling set for height correction (page 27)

Material:	Stainless steel, aluminum
Dimensions:	155x90-120x155 mm (W x H x D)
Instl depth:	90-120 mm (floor)
Protection:	IP10
Load:	Area load max. 120 kg
Supply line:	2 x lateral, 3 x back, 3 x below, each \varnothing 26 mm
Leveling:	30 mm
Flooring insert:	15 mm
Feature:	Can be closed with inserted plugs.





8904B

Item No.:	Equipment:
8904B	4 x socket
8904B1	3 x socket, 1 x RJ45 double
8904B2	3 x socket, 1 x aerial
8904B3	2 x socket, 1 x RJ45 double, 1 x aerial

Opt. parts: 12201 leveling set for height correction (page 27)

Material:	Stainless steel, aluminum
Dimensions:	205 x 90–120 x 155 mm (W x H x D)
Instl depth:	90–120 mm (floor)
Protection:	IP20
Load:	Area load max. 120 kg
Supply line:	2 x lateral, 2 x back, 2 x below, each \varnothing 26 mm
Leveling:	30 mm
Flooring insert:	15 mm
Feature:	Lid can be closed with inserted plugs.



8904BB

Item No.:	Equipment:
8904BB	4 x socket
8904BB1	3 x socket, 1 x RJ45 double
8904BB2	3 x socket, 1 x aerial
8904BB3	2 x socket, 1 x RJ45 double, 1 x aerial

Opt. parts: 12201 leveling set for height correction (page 27)

Material:	Stainless steel, aluminum
Dimensions:	205 x 90–120 x 155 mm (W x H x D)
Instl depth:	90–120 mm (floor)
Protection:	IP10
Load:	Area load max. 120 kg
Supply line:	2 x lateral, 2 x back, 2 x below, each \varnothing 26 mm
Leveling:	30 mm
Flooring insert:	15 mm
Feature:	Lid can be closed with inserted plugs.





8908B

Item No.:	Equipment:
8908B	8 x socket
8908B1	4 x socket, 4 x RJ45 double
<hr/>	
Opt. parts:	12201 leveling set for height correction (page 27)
<hr/>	
Material:	Stainless steel, aluminum
Dimensions:	205 x 90–120 x 205 mm (W x H x D)
Instl depth:	90–120 mm (floor)
Protection:	IP20
Load:	Area load max. 120 kg
Supply line:	2 x front, 8 x lateral, 2 x back, 4 x below, each Ø 26 mm
Leveling:	30 mm
Flooring insert:	15 mm
Feature:	Lid can be closed with inserted plugs.

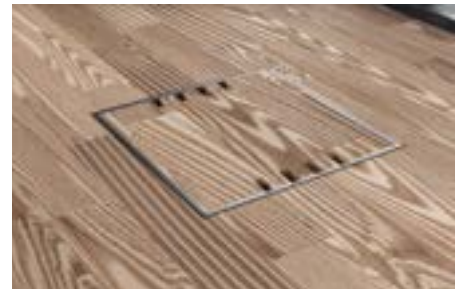
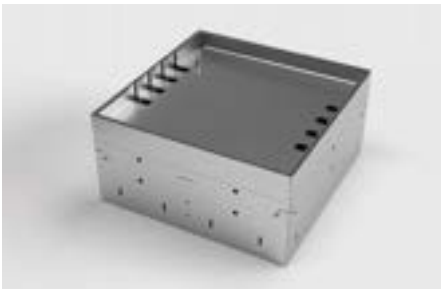

8908BB

Item No.:	Equipment:
8908BB	8 x socket
8908BB1	4 x socket, 4 x RJ45 double
8908BB2	6 x socket, 6 x RJ45 single
<hr/>	
Opt. parts:	12201 leveling set for height correction (page 27)
<hr/>	
Material:	Stainless steel, aluminum
Dimensions:	205 x 90–120 x 205 mm (W x H x D)
Instl depth:	90–120 mm (floor)
Protection:	IP10
Load:	Area load max. 120 kg
Supply line:	2 x front, 8 x lateral, 2 x back, 4 x below, each Ø 26 mm
Leveling:	30 mm
Flooring insert:	15 mm
Feature:	Lid can be closed with inserted plugs.





12201

Parts for 8901 to 8908:

Item No. 12201 leveling set for height correction of floor sockets

Professional height correction for floor boxes. The leveling set is made of stainless steel. It is developed for the 89 series and can be used for models 8901 to 8908.

Dimensions: 267 x 150 x 207 mm (W x H x D)

Leveling range: 53-153 mm in 20 mm steps

The delivery takes place without the illustrated floor box.



8912B

Item No.:	Equipment:
8912B	12 x socket
8912B1	8 x socket, 4 x RJ45 double

Opt. parts: 12202 leveling set for height correction (page 28)

Material: Stainless steel, Aluminum
Dimensions: 309 x 90-120 x 305 mm (W x H x D)
Instl depth: 90-120 mm (floor)
Protection: IP10
Load: Area load max. 120 kg
Supply line: 2 x front, 8 x lateral, 2 x back, 8 x below, each Ø 26 mm
Leveling: 30 mm
flooring insert: 15 mm
Feature: Flooring can be integrated, can be closed with inserted plugs.





12202

Parts for the floor tank 8912B:

Item No. 12202 leveling set for height correction of floor tanks

Professional height correction for floor boxes. The leveling set is made of stainless steel.

Dimensions: 308 x 150 x 305 mm (W x H x D)

Leveling range: 53-153 mm in 20 mm steps

The delivery takes place without the illustrated floor box.



8920B

Item No.:	Equipment:
8920B	20x socket
8920B1	10x socket, 10x RJ45 double

Opt. parts: 12203 leveling set for height correction (page 29)

Material: Stainless steel, aluminum
Dimensions: 305 x 90-120 x 505 mm (W x H x D)
Instl depth: 90-120 mm (floor)
Protection: IP10
Load: Area load max. 120 kg
Supply line: 2x front, 12x lateral, 2x back, 12x below, each Ø 26 mm
Leveling: 30 mm
Flooring insert: 15 mm
Feature: Flooring can be integrated, can be closed with inserted plugs. The lid has a brush outlet.





12203

Parts for the floor tank 8920B:

Item No. 12203 leveling set for height correction of floor tanks

Professional height correction for floor boxes. The leveling set is made of stainless steel.

Dimensions: 368x150x568 mm (WxHxD)

Leveling range: 53-153 mm in 20 mm steps

The delivery takes place without the illustrated floor box.



9901A

Item No.:	Equipment:
9901A	1x socket
9901A1	1x RJ45 double

Opt. parts: 12102 screed placeholder made of EPS (on demand)

Material:	Aluminum
Dimensions:	Rim Ø 140 mm, Ø 120x72 mm
Instl depth:	70 mm (floor)
Protection:	IP20
Load:	Area load max. 200 kg
Supply line:	2x back, 2x below, each Ø 25 mm
Flooring insert:	5 mm
Feature:	Flooring can be integrated in the reversible lid, lid can be closed with inserted plugs.





9902A

Item No.:	Equipment:
9902A	2 x socket
9902A1	1 x socket, 1 x RJ45 double
9902A2	1 x socket, 1 x aerial

Opt. parts: 12107 screed placeholder made of EPS (on demand)

Material:	Aluminum
Dimensions:	Rim Ø 170 mm, Ø 150 x 72 mm
Instl depth:	70 mm (floor)
Protection:	IP20
Load:	Area load max. 200 kg
Supply line:	2 x back, 2 x below, each Ø 25 mm
Flooring insert:	5 mm
Feature:	Flooring can be integrated in the reversible lid, lid can be closed with inserted plugs.



9902B

Item No.:	Equipment:
9902B	2 x socket
9902B1	1 x socket, 1 x RJ45 double
9902B2	1 x socket, 1 x aerial
9902B3	1 x socket, 1 x USB charge double

Opt. parts: 12107 screed placeholder made of EPS (on demand)

Material:	Aluminum, stainless steel
Dimensions:	Ø 150 x 80-105 mm
Instl depth:	80-105 mm (floor)
Protection:	IP20
Load:	Area load max. 200 kg
Supply line:	2 x back, 2 x below, each Ø 25 mm
Feature:	Can be closed with inserted plugs. Possible height adjustment (20 mm) via integrable leveling feet.





9902D

Item No.:	Equipment:
9902D	2 x socket
9902D1	1 x socket, 1 x RJ45 double
9902D2	1 x socket, 1 x aerial

Opt. parts: 12107 screed placeholder made of EPS (on demand)

Material:	Aluminum
Dimensions:	Rim \varnothing 170 mm, \varnothing 150 x 77 mm
Instl depth:	75 mm (floor)
Protection:	IP65
Load:	Area load max. 500 kg
Supply line:	2 x back, 2 x below, each \varnothing 25 mm
Feature:	By turning the lid by 180° it is suitable for cleaning with wet sweepers. Can be closed with inserted plugs.



9904A

Item No.:	Equipment:
9904A	4 x socket
9904A1	2 x socket, 2 x RJ45 double
9904A2	2 x socket, 1 x RJ45 double, 1 x aerial
9904A3	3 x socket, 1 x RJ45 double

Opt. parts: 12106 screed placeholder made of EPS (on demand)

Material:	Aluminum, Stainless steel
Dimensions:	Rim \varnothing 220 mm, \varnothing 205 x 81 mm
Instl depth:	77 mm (floor)
Protection:	IP20
Load:	Area load max. 200 kg
Supply line:	2 x front, 2 x back, 4 x below, each \varnothing 26 mm
Flooring insert:	6 mm
Feature:	Flooring can be integrated in the reversible cover, can be closed with inserted plugs.





Floor socket
→ Outdoor



7002A



Item No.: 7002A	Equipment: 2 x socket, 1 x RJ45 double
Material:	Aluminum, stainless steel
Dimensions:	Ø 150 x 104 mm
Instl depth:	104 mm (floor)
Protection:	IP67
Load:	Area load max. 900 kg
Supply line:	2 x below each Ø 25 mm, 2 x lateral each M25 x 1,5 mm
Feature:	Lockable with a tool, waterproof when closed.



7501A



Item No.: 7501A	Equipment: 1x socket
Opt. parts:	12256 rain protection set (page 39)
Material:	Aluminum, PVC, stainless steel
Dimensions:	Ø 114 x 82 mm
Instl depth:	80 mm (floor)
Protection:	IP67
Load:	Area load max. 900 kg
Supply line:	2 x lateral, each M25 x 1,5 mm
Feature:	Lockable with a special key, waterproof when closed.





7601A



Item No.: 7601A	Equipment: 1 x socket
Opt. parts:	12256 rain protection set (page 39)
Material:	Aluminum, PVC, stainless steel
Dimensions:	100 x 82 x 100 mm (W x H x D)
Instl depth:	82 mm (floor)
Protection:	IP67
Load:	Area load max. 900 kg
Supply line:	2 x lateral, each M25 x 1,5 mm
Feature:	Lockable with a special key, waterproof when closed.



7602A



Item No.: 7602A 7602A1	Equipment: 2 x socket 1 x socket, 1 x RJ45 single
Opt. parts:	12256 rain protection set (page 39)
Material:	Aluminum, PVC, stainless steel
Dimensions:	200 x 82 x 100 mm (W x H x D)
Instl depth:	82 mm (floor)
Protection:	IP67
Load:	Area load max. 900 kg
Supply line:	2 x front, 2 x back, each M25 x 1,5 mm
Feature:	Lockable with a special key, waterproof when closed.





7701AW



Item No.:	Equipment:
7701A	1x socket
7701A1	1x RJ45 single

Opt. parts: 12256 rain protection set (page 39)

Material:	Aluminum, stainless steel
Dimensions:	Ø 90x78,5 mm
Instl depth:	78,5 mm (floor)
Protection:	IP67
Load:	Area load max. 900 kg
Supply line:	2x lateral, each M25x1,5 mm
Feature:	Lockable with a special key, waterproof when closed.



7702A



Item No.:	Equipment:
7702A	2x socket

Opt. parts: 12210 ground anchor (page 37)
12251 leveling ring (page 38)
12255 rain protection set (page 38)

Material:	Aluminum, PVC, Stainless steel
Dimensions:	Ø 170x120 mm
Instl depth:	120 mm (floor)
Protection:	IP67
Load:	Area load max. 200 kg
Supply line:	2x lateral, each M25x1,5 mm
Feature:	Lockable with a special key, waterproof when closed.





7704A



Item No.: 7704A
Equipment: 4 x socket

Opt. parts: 12210 ground anchor (siehe below)
12251 leveling ring (page 38)
12255 rain protection set (page 38)

Material: Aluminum, PVC, Stainless steel
Dimensions: Ø 170 x 120 mm
Instl depth: 120 mm (floor)
Protection: IP67
Load: Area load max. 200 kg
Supply line: 2 x lateral, each M25 x 1,5 mm
Feature: Lockable with a special key, waterproof when closed.



12210



Parts for 7702A, 7704A and 7705A:

Item No. 12210 ground anchor

Ground anchor made from stainless steel for the installation of the floor sockets 7702A, 7704A and 7705A in the mortar bed.

Dimensions: 150 x 70 x 15 mm (W x H x D)





12251



Parts for 7702A, 7704A and 7705A:
Item No. 12251 leveling ring

Solid aluminum ring for fastening the floor sockets 7702A, 7704A and 7705A in the wooden floor/raised floor.

leveling ring dimensions: \varnothing 200 x 8 mm



12255



Parts for 7702A and 7704A:
Item No. 12255 extension tube and protective cap

Extension tube made of solid PVC (RAL 7011 gray) and protective cap made of soft PVC (black) to protect against rain when plugged in.

Dimensions extension tube: \varnothing 170 x 120 mm

Dimensions protective cap: \varnothing 174 x 62 mm





12256



Parts for 7501A, 7601A, 7602A and 7701AW:

Item No. 12256 extension tube and protective cap

Extension tube made of solid PVC (RAL 7011 gray) and protective cap made of soft PVC (black) to protect against rain when plugged in.

Dimensions extension tube: \varnothing 79 x 80 mm

Dimensions protective cap: \varnothing 82 x 42 mm





Raised access floor boxes



8501B

Item No.:	Equipment:
8501B	1x socket
8501B1	1x RJ45 double
8501B2	1x aerial

Material:	Stainless steel, aluminum
Dimensions:	150x90x150 mm (WxHxD)
Instl depth:	90 mm (floor)
Protection:	IP20
Load:	Area load max. 120 kg
Supply line:	2x lateral, 2x back, 2x below, each \varnothing 26 mm
Leveling:	30 mm
Flooring insert:	15 mm
Feature:	Covering can be integrated, can be closed with inserted plugs.

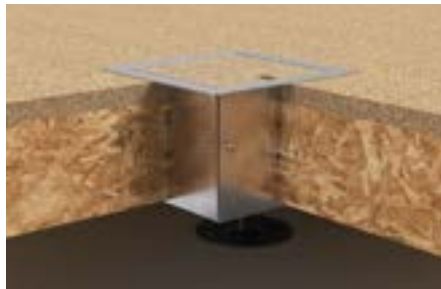

8501E

Item No.:	Equipment:
8501E	1x socket
8501E1	1x RJ45 double
8501E2	1x aerial

Material:	Stainless steel, aluminum
Dimensions:	150x90x150 mm (WxHxD)
Instl depth:	90 mm (floor)
Protection:	IP20
Load:	Area load max. 120 kg
Supply line:	2x lateral, 2x back, 2x below, each \varnothing 26 mm
Leveling:	30 mm
Feature:	Can be closed with inserted plugs.





8502B

Item No.:	Equipment:
8502B	2 x socket
8502B1	1 x socket, 1 x RJ45 double
8502B2	1 x socket, 1 x aerial
8502B3	2 x socket, 2 x RJ45 single

Material:	Stainless steel, aluminum
Dimensions:	180x90x180 mm (WxHxD)
Instl depth:	90 mm (floor)
Protection:	IP20
Load:	Area load max. 120 kg
Supply line:	2 x lateral, 2 x back, 2 x below, each Ø 26 mm
Leveling:	30 mm
Flooring insert:	15 mm
Feature:	Covering can be integrated, can be closed with inserted plugs.



8502E

Item No.:	Equipment:
8502E	2 x socket
8502E1	1 x socket, 1 x RJ45 double (brush outlet)
8502E2	1 x socket, 1 x aerial (brush outlet)
8502E3	2 x socket, 2 x RJ45 single (brush outlet)

Material:	Stainless steel, aluminum
Dimensions:	180x90x180 mm (WxHxD)
Instl depth:	90 mm (floor)
Protection:	IP20 (IP10 with brush outlet)
Load:	Area load max. 120 kg
Supply line:	2 x lateral, 2 x back, 2 x below, each Ø 26 mm
Leveling:	30 mm
Feature:	Can be closed with inserted plugs.



8502E1/E2/E3



8504B

Item No.:	Equipment:
8504B	4x socket
8504B1	3x socket, 1x RJ45 double
8504B2	3x socket, 1x aerial
8504B3	2x socket, 1x aerial, 1x RJ45 double

Material:	Stainless steel, aluminum
Dimensions:	230 x 90 x 180 mm (W x H x D)
Instl depth:	90 mm (floor)
Protection:	IP20
Load:	Area load max. 120 kg
Supply line:	2x lateral, 2x back, 2x below, each Ø 26 mm
Leveling:	30 mm
Flooring insert:	15 mm
Feature:	Covering can be integrated, can be closed with inserted plugs.

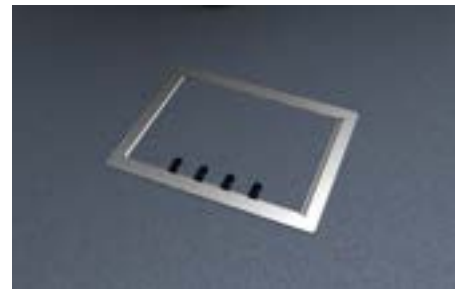

8504E

Item No.:	Equipment:
8504E	4x socket
8504E1	3x socket, 1x RJ45 double
8504E2	3x socket, 1x aerial
8504E3	2x socket, 1x aerial, 1x RJ45 double

Material:	Stainless steel, aluminum
Dimensions:	230 x 90 x 180 mm (W x H x D)
Instl depth:	90 mm (floor)
Protection:	IP10
Load:	Area load max. 120 kg
Supply line:	2x lateral, 2x back, 2x below, each Ø 26 mm
Leveling:	30 mm
Feature:	Can be closed with inserted plugs.





8508B

Item No.:	Equipment:
8508B	8 x socket
8508B1	4 x socket, 4 x RJ45 double
Material:	Stainless steel, aluminum
Dimensions:	230 x 90 x 230 mm (W x H x D)
Instl depth:	90 mm (floor)
Protection:	IP20
Load:	Area load max. 120 kg
Supply line:	2 x front, 8 x lateral, 2 x back, 4 x below, each Ø 26 mm
Leveling:	30 mm
Flooring insert:	15 mm
Feature:	Covering can be integrated, can be closed with inserted plugs.

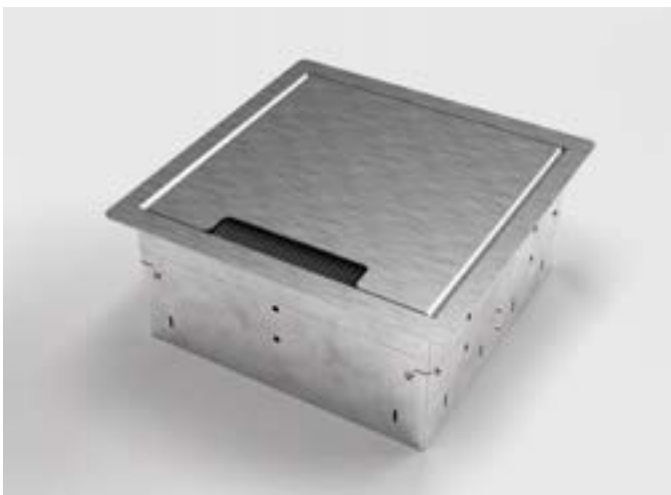

8508E

Item No.:	Equipment:
8508E	8 x socket
8508E1	4 x socket, 4 x RJ45 double
8508E2	6 x socket, 6 x RJ45 single
Material:	Stainless steel, aluminum
Dimensions:	230 x 90 x 230 mm (W x H x D)
Instl depth:	90 mm (floor)
Protection:	IP10
Load:	Area load max. 120 kg
Supply line:	2 x front, 8 x lateral, 2 x back, 4 x below, each Ø 26 mm
Leveling:	30 mm
Feature:	Can be closed with inserted plugs.

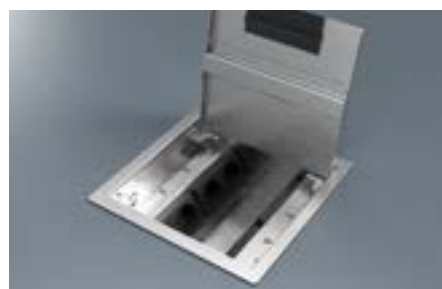



8512B

Item No.:	Equipment:
8512B	12 x socket
8512B1	8 x socket, 4 x RJ45 double

Material:	Stainless steel, aluminum
Dimensions:	350 x 90 x 350 mm (W x H x D)
Instl depth:	90 mm (floor)
Protection:	IP10
Load:	Area load max. 120 kg
Supply line:	2 x front, 8 x lateral, 2 x back, 8 x below, each Ø 26 mm
Leveling:	30 mm
Flooring insert:	15 mm
Feature:	Covering can be integrated, lid can be closed with inserted plugs.



8902H

Item No.:	Equipment:
8902H	2 x socket
8902H1	1 x socket, 1 x RJ45 double
8902H2	1 x socket, 1 x aerial

Material:	Stainless steel, aluminum
Dimensions:	200 x 90-120 x 200 mm (W x H x D)
Instl depth:	90-120 mm (floor)
Protection:	IP20
Load:	Area load max. 120 kg
Supply line:	2 x lateral, 2 x back, 2 x below, each Ø 26 mm
Leveling:	30 mm
Flooring insert:	15 mm
Feature:	Lid can be closed with inserted plugs.

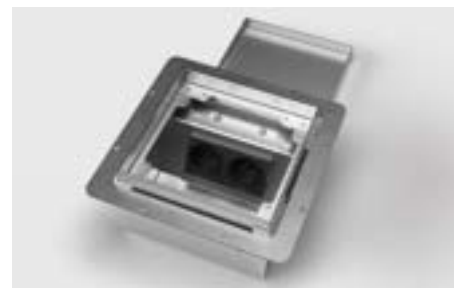
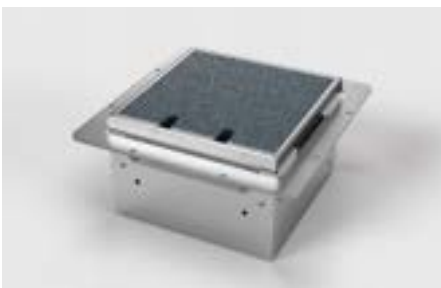



8902HB

Item No.:	Equipment:
8902HB	2 x socket
8902HB1	1 x socket, 1 x RJ45 double
8902HB2	1 x socket, 1 x aerial

Material:	Stainless steel, aluminum
Dimensions:	200x90-120x200 mm (W x H x D)
Instl depth:	90-120 mm (floor)
Protection:	IP10
Load:	Area load max. 120 kg
Supply line:	2 x lateral, 2 x back, 2 x below, each \varnothing 26 mm
Leveling:	30 mm
Flooring insert:	15 mm
Feature:	Lid can be closed with inserted plugs.

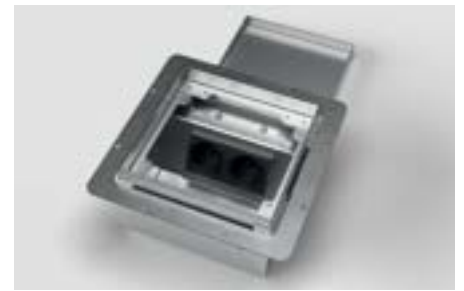
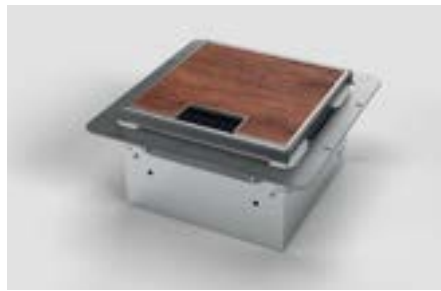

8904H

Item No.:	Equipment:
8904H	4 x socket
8904H1	3 x socket, 1 x RJ45 double
8904H2	3 x socket, 1 x aerial
8904H3	2 x socket, 1 x RJ45 double, 1 x aerial

Material:	Stainless steel, aluminum
Dimensions:	250x90-120x200 mm (W x H x D)
Instl depth:	90-120 mm (floor)
Protection:	IP20
Load:	Area load max. 120 kg
Supply line:	2 x lateral, 2 x back, 2 x below, each \varnothing 25 mm
Leveling:	30 mm
Flooring insert:	15 mm
Feature:	Lid can be closed with inserted plugs.





8904HB

Item No.:	Equipment:
8904HB	4 x socket
8904HB1	3 x socket, 1x RJ45 double
8904HB2	3 x socket, 1x aerial
8904HB3	2 x socket, 1x RJ45 double, 1x aerial

Material:	Stainless steel, aluminum
Dimensions:	250 x 90–120 x 200 mm (W x H x D)
Instl depth:	90–120 mm (floor)
Protection:	IP10
Load:	Area load max. 120 kg
Supply line:	2 x lateral, 2 x back, 2 x below, each Ø 25 mm
Leveling:	30 mm
Flooring insert:	15 mm
Feature:	Covering can be integrated, lid can be closed with inserted plugs.



8908H

Item No.:	Equipment:
8908H	8 x socket
8908H1	4 x socket, 4 x RJ45 double

Material:	Stainless steel, aluminum
Dimensions:	250 x 90–120 x 250 mm (W x H x D)
Instl depth:	90–120 mm (floor)
Protection:	IP20
Load:	Area load max. 120 kg
Supply line:	2 x front, 8 x lateral, 2 x back, 4 x below, each Ø 26 mm
Leveling:	30 mm
Flooring insert:	15 mm
Feature:	Covering can be integrated, lid can be closed with inserted plugs.





8908HB

Item No.:	Equipment:
8908HB	8 x socket
8908HB1	4 x socket, 4 x RJ45 double
8908HB2	6 x socket, 6 x RJ45 single
Material: Stainless steel, aluminum	
Dimensions:	250 x 90–120 x 250 mm (W x H x D)
Instl depth:	90–120 mm (floor)
Protection:	IP10
Load:	Area load max. 120 kg
Supply line:	2 x front, 8 x lateral, 2 x back, 4 x below, each Ø 26 mm
Leveling:	30 mm
Flooring insert:	15 mm
Feature:	Covering can be integrated, lid can be closed with inserted plugs.

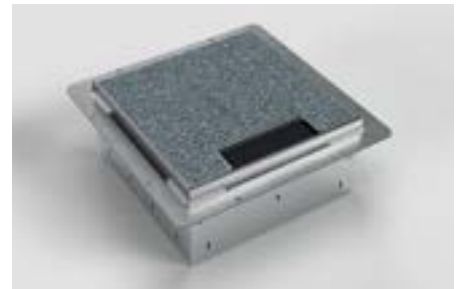

9908A

Item No.:	Equipment:
9908A	8 x socket
9908A1	4 x socket, 4 x RJ45 double
9908A2	6 x socket, 6 x RJ45 single
Opt. parts:	12101 screed placeholder made of EPS (on demand)
Material: Aluminum, stainless steel	
Dimensions:	Ø 320 x 80 mm
Instl depth:	76 mm (floor)
Protection:	IP10
Load:	Area load max. 200 kg
Supply line:	8 x lateral, 8 x below, each Ø 26 mm
Flooring insert:	6 mm
Feature:	Reversible lid, covering can be integrated, lid can be closed with inserted plugs.

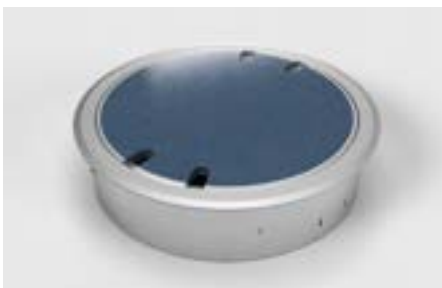



CEE floor tank



6522A

Item No.: 6522A **Equipment:** 1x CEE 5/16A, 1x CEE 5/32A, 2x socket

Material: Aluminum, stainless steel
Dimensions: 400 x 117 x 400 mm (W x H x D)
Instl depth: 117 mm (floor)
Protection: IP65
Load: Area load max. 900 kg
Supply line: 4 x back, each \varnothing 25 mm
Feature: Lockable with a tool.



6523Q

Item No.: 6523Q **Equipment:** 1x CEE 5/16A 400V/6h, 1x CEE 5/32A 400V/6h, 3x socket

Material: Aluminum, stainless steel
Dimensions: 400 x 167 x 400 mm (W x H x D)
Instl depth: 167 mm (floor)
Protection: IP65 (with attached tube IP12)
Load: Area load max. 900 kg
Supply line: 4 x back, each \varnothing 25 mm
Feature: Lockable with a tool, can be used through the tube with the lid closed.

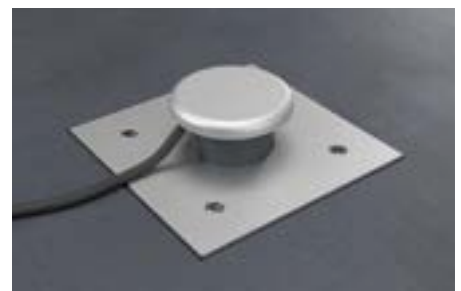



6610A



Item No.:	Equipment:
6610A1	1x CEE 5/16A 400V/6h
6610A2	1x CEE 5/32A 400V/6h

Material:	Aluminum, stainless steel
Dimensions:	256 x 210 x 500 mm (W x H x D)
Instl depth:	210 mm (floor)
Protection:	IP67 (electr. units)
Load:	Area load max. 6500 kg
Supply line:	2x front, each Ø 32 mm
Drainage:	1 x below opening 50 mm
Feature:	Lockable with tools, can be closed with inserted plugs. When closed, the floor tank is not waterproof. A drainage pipe for drainage of the housing must be connected outdoors. Lid with gas pressure spring.



6620A



Item No.:	Equipment:
6620A	1x CEE 5/16A 400V/6h, 1x CEE 5/32A 400V/6h

Material:	Aluminum, Stainless steel
Dimensions:	306 x 210 x 500 mm (W x H x D)
Instl depth:	210 mm (floor)
Protection:	IP67 (electr. units)
Load:	Area load max. 6500 kg
Supply line:	2x front, each Ø 32 mm
Drainage:	1 x below opening 50 mm
Feature:	Lockable with tools, can be closed with inserted plugs. When closed, the floor tank is not waterproof. A drainage pipe for drainage of the housing must be connected outdoors. Lid with gas pressure spring.





6710A



Item No.:	Equipment:
6710A1	1 x connection schuko
6710A2	1 x connection CEE 5/16A 400V/6h
6710A3	1 x connection CEE 5/32A 400V/6h

Material:	Aluminum, stainless steel
Dimensions:	206 x 474 x 200 mm (W x H x D)
Instl depth:	474 mm (floor)
Protection:	IP68 (electr. units)
Load:	Area load max. 7,5t
Supply line:	2 x lateral, each \varnothing 25 mm
Feature:	Lockable with tools, can be closed with inserted plugs. When closed, the floor tank is not waterproof. A drainage pipe for drainage of the housing must be connected outdoors. Slip resistance (R13 DIN 51130).



7012A



Item No.:	Equipment:
7012A1	1 x CEE 5/16A 400V/6h, 2 x socket
7012A2	1 x CEE 5/32A 400V/6h, 2 x socket

Material:	Aluminum, stainless steel
Dimensions:	\varnothing 200 x 148 mm
Instl depth:	148 mm (floor)
Protection:	IP67
Load:	Area load max. 900 kg
Supply line:	3 x below, each \varnothing 25 mm / 2 x lateral, each M25 x 1,5 mm
Feature:	Lockable with a special key.

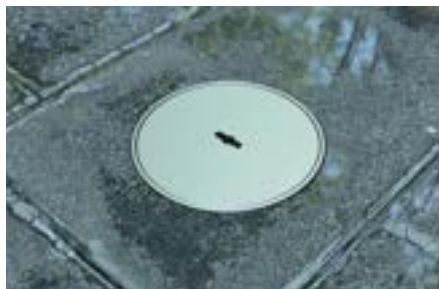



7012A63



Item No.:	Equipment:
7012A63	1 x CEE 5/63A 400V/6h
Material:	Aluminum, stainless steel
Dimensions:	Ø 200 x 223 mm
Instl depth:	223 mm (floor)
Protection:	IP67
Load:	Area load max. 900 kg
Supply line:	1 x below, Ø 43 mm
Feature:	Lockable with a special key.



7022A



Item No.:	Equipment:
7022A	1x CEE 5/16A 400V/6h, 1x CEE 5/32A 400V/6h, 2x socket
Material:	Aluminum, stainless steel
Dimensions:	Ø 250 x 148 mm
Instl depth:	148 mm (floor)
Protection:	IP67
Load:	Area load max. 900 kg
Supply line:	3x below, each Ø 25 mm / 2x lateral, each M25 x 1,5 mm
Feature:	Lockable with a special key.





7705A



Item No.:	Equipment:
7705A1	1 x CEE 5/16A 400V/6h
7705A2	1 x CEE 5/32A 400V/6h

Opt. parts:	12210 ground anchor (page 37)
	12251 leveling ring (page 38)

Material:	PVC, aluminum
Dimensions:	Ø 170 x 120 mm
Instl depth:	120 mm (floor)
Protection:	IP67
Load:	Area load max. 200 kg
Supply line:	2 x lateral, each M25 x1,5
Feature:	Lockable with a special key.



8310A

Item No.:	Equipment:
8310A1	1 x CEE 5/16A 400V/6h
8310A2	1 x CEE 5/32A 400V/6h

Opt. parts:	12184 screed placeholder made of EPS (on demand)
--------------------	--

Material:	Aluminum, Stainless steel
Dimensions:	150 x 130 x 150 mm (W x H x D)
Instl depth:	130 mm (floor)
Protection:	IP65
Load:	Area load max. 900 kg
Supply line:	2 x back, each Ø 25 mm
Feature:	Lockable without tools.

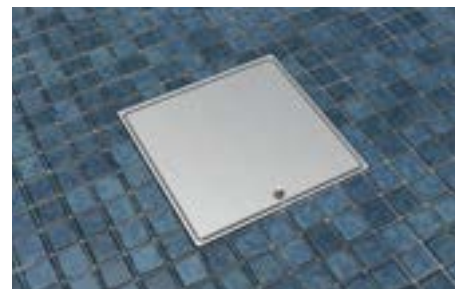



8314A

Item No.:	Equipment:
8314A1	1 x CEE 5/16A 400V/6h, 2 x socket, 2 x RJ45 double
8314A2	1 x CEE 5/32A 400V/6h, 2 x socket, 2 x RJ45 double

Opt. parts: 12185 screed placeholder made of EPS (on demand)

Material:	Aluminum, stainless steel
Dimensions:	250 x 131 x 160 mm (W x H x D)
Instl depth:	131 mm (floor)
Protection:	IP65
Load:	Area load max. 500 kg
Supply line:	4 x back, each Ø 25 mm
Feature:	Lockable without tools. With cable protection.



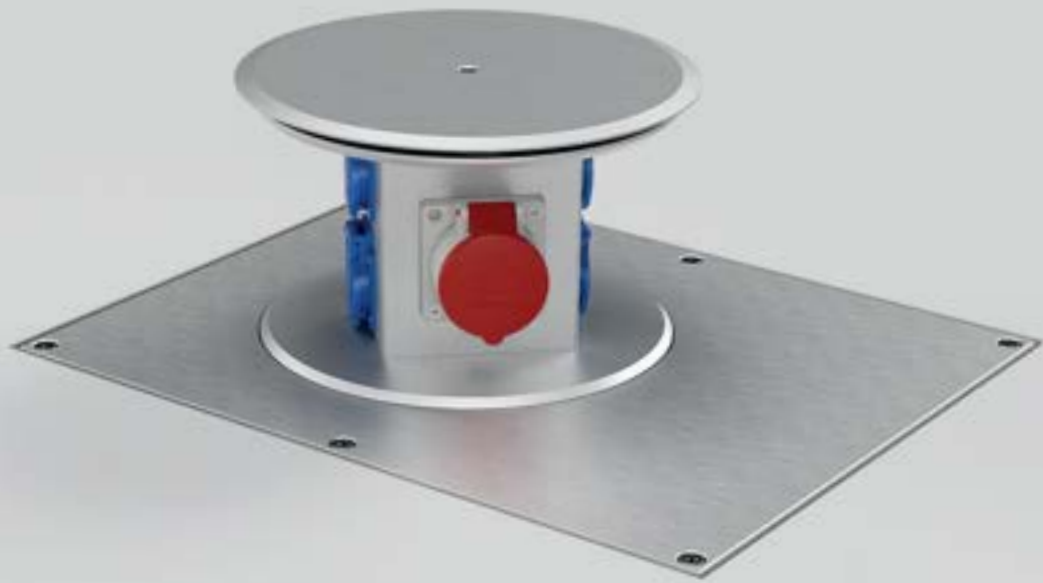

Retractable power distributors



SV111



Equipment:	1 x socket
Material:	Aluminum, PVC
Dimensions:	Ø 126 x 152 mm
Base plate:	145 x 145 mm (B x D)
Instl depth:	149 mm (floor)
Protection:	IP67
Load:	Area load max. 900 kg
Supply line:	2 x lateral, each M25 x 1,5 mm
Feature:	Salt water resistant, waterproof when closed. The devices are raised and lowered using a special key. With connection kit including potting compound.



SV112



Equipment:	1 x socket
Material:	Aluminum, PVC
Dimensions:	125 x 152 x 125 mm (W x H x D)
Base plate:	145 x 145 mm (B x D)
Instl depth:	149 mm (floor)
Protection:	IP67
Load:	Area load max. 900 kg
Supply line:	2 x lateral, each M25 x 1,5 mm
Feature:	Salt water resistant, waterproof when closed. The devices are raised and lowered using a special key. With connection kit including potting compound.

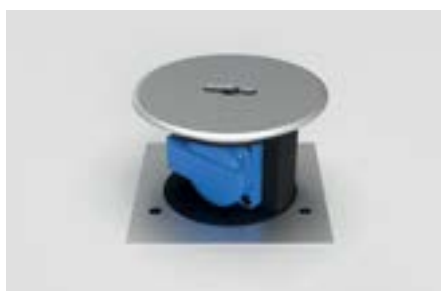



SV301



Item No.:	Equipment:
SV301-2	4 x socket
SV301-3	1 x CEE 5/16A 400V/6h
SV301-4	1 x CEE 5/32A 400V/6h
SV301-5	3 x socket · 1 x CEE adapter 16A

Material:	Aluminum, PVC
Dimensions:	Ø 210 x 234 mm
Base plate:	Ø 280 mm
Instl depth:	229 mm (floor)
Protection:	IP67
Load:	Area load max. 6,5t
Supply line:	1x lateral M25 x 1,5 mm / 2x below, each Ø 25 mm
Feature:	Salt water resistant, waterproof when closed. The devices are raised and lowered using a special key. With connection kit including potting compound.



SV302



Item No.:	Equipment:
SV302-2	4 x socket
SV302-3	1 x CEE 5/16A 400V/6h
SV302-4	1 x CEE 5/32A 400V/6h
SV302-5	3 x socket · 1 x CEE Adapter 16A

Material:	Aluminum, PVC
Dimensions:	205 x 234 x 205 mm (W x H x D)
Base plate:	Ø 280 mm
Instl depth:	229 mm (floor)
Protection:	IP67
Load:	Area load max. 6,5t
Supply line:	1x lateral M25 x 1,5 mm / 2x below, each Ø 25 mm
Feature:	Salt water resistant, waterproof when closed. The devices are raised and lowered using a special key. With connection kit including potting compound.





SV501



Item No.:	Equipment:
SV501-1	8x socket
SV501-2	1 x CEE 5/16A 400V/6h, 6 x socket
SV501-3	1 x CEE 5/32A 400V/6h, 6 x socket
SV501-4	1 x CEE 5/16A 400V/6h, 1 x CEE 5/32A 400V/6h, 4xsocket

Material:	Stainless steel, Aluminum
Dimensions:	500 x 256 x 400 mm (W x H x D)
Instl depth:	251 mm (floor)
Protection:	IP65
Load:	Area load max. 6,5t
Supply line:	2x lateral, each \varnothing 25 mm / 2x lateral, each \varnothing 32 mm / 1x below drainage \varnothing 25 mm
Feature:	Salt water resistant, waterproof when closed and opened. Raise and lower with a crank.

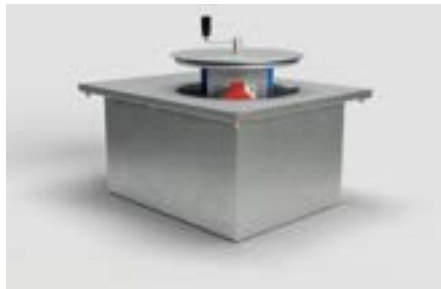



Power columns



ES102



Item No.:	Equipment:
ES102-1	2x socket (black, RAL 9017 frosted)
ES102-2	2x socket (white, RAL 9010)
ES102-3	2x socket (white aluminum, RAL 9006 frosted)
ES102-4	2x socket (grey-brown, RAL 8019 frosted)

Parts: BAES102 ground anchor (page 72)

Material:	Stainless steel
Dimensions:	100 x 255 x 80 mm (W x H x D)
Base plate:	130 x 110 mm (B x D)
Protection:	IP44
Supply line:	2x below, each \varnothing 25 mm
Weight:	3500 g



ES301



Item No.:	Equipment:
ES301-1	2x socket
ES301-2	1x socket, 1x switch
ES301-3	1x socket, 1x USB charge double
ES301-4	1x socket, 1x RJ45 double

Parts: BAES301 ground anchor (page 72)

Material:	Stainless steel
Dimensions:	100 x 230 x 62,5 mm (W x H x D)
Base plate:	130 x 82 mm (B x D)
Protection:	IP44
Supply line:	2x below, each \varnothing 25 mm
Weight:	1200 g





ES321



Item No.:	Equipment:
ES321-1	2 x socket · 2 x CEE 3/16A 230V/6h
ES321-2	2 x socket · 1 x CEE 5/16A 400V/6h
ES321-3	4 x socket

Parts: BAES321 ground anchor (page 73)

Material:	Stainless steel
Dimensions:	Ø 129 x 446 mm
Base plate:	Ø 180 mm
Protection:	IP44
Supply line:	from below
Color:	DB701 or DB703 (RAL-Color possible)
Weight:	3700 g



ES323



Item No.:	Equipment:
ES323-1	1 x CEE 5/16A 400V/6h · 4 x CEE 3/16A 230V/6h
ES323-2	2 x socket · 2 x CEE 5/16A 400V/6h

Parts: BAES323 ground anchor (page 73)

Material:	Stainless steel
Dimensions:	Ø 154 x 700 mm
Base plate:	Ø 210 mm
Protection:	IP44
Supply line:	from below
Color:	DB701 or DB703 (RAL-Color possible)
Weight:	6400 g





Color DB703



ES323-EM



Equipment: 4 x socket
Fuse: 4 x RCBO, 16A, 0,03A, 2-p, 1DU
Connection: 5 x terminal block Phoenix UT 10

Parts: BAES323 ground anchor (page 73)

Material: Stainless steel
Dimensions: Ø 154 x 700 mm
Base plate: Ø 210 mm
Protection: IP44
Supply line: from below
Color: DB701 or DB703 (RAL-Color possible)
Weight: 6,3 kg
Feature: Charging points can each be equipped with an energy meter (single-phase).



ES401



Item No.: ES401-1
Equipment: 4 x CEE 3/16A 230V/6h
Fuse: 4 x RCBO, 16A, 0.03A, 2-p
Connection: 1 x terminal box 2 x 5 x 10 mm²

Item No.: ES401-2
Equipment: 4 x socket · 1 x CEE 5/32A 400V/6h ·
 1 x CEE 5/63A 400V/6h
Fuse: 4 x MCB, B16, 1-p · 1 x MCB, C16, 3-p · 1 x MCB, C32, 3-p
 1 x RCCB, 40A, 0.03A, 4-p
Connection: 1 x Terminalbox 2 x 5 x 10 mm²

Parts: BAES401 ground anchor (page 74)

Material: Stainless steel
Dimensions: 180 x 1207 x 133 mm (W x H x D)
Base plate: 230 x 235 mm (B x D)
Protection: IP44
Supply line: from below
Color: Stainless steel
Weight: 11,68 kg



Color DB703



Color DB701



ES882



- Equipment:** 4 x CEE 3/16A 230V/6h
- Material:** Aluminum
- Dimensions:** 229 x 600 x 229 mm (W x H x D)
- Protection:** IP44
- Supply line:** 1 x below \varnothing 52 mm
- Color:** DB701 or DB703 (RAL-Color possible)
- Weight:** 5,7 kg

ES884



- Equipment:** 4 x CEE 3/16A 230V/6h · 2 x water connection
- Fuse:** 4 x RCBO, 16A, 0.03A, 2-p
- Material:** Aluminum
- Dimensions:** 253 x 800 x 350 mm (W x H x D)
- Protection:** IP44
- Supply line:** 1 x below opening
- Color:** DB701
- Weight:** 11,69 kg



Color DB703



Color DB703



ESP14



Item No.: ESP14-1
Equipment: 4 x socket · 1 x CEE 5/16A 400V/6h
Fuse: 2 x MCB, B16, 1-p · 1 x MCB, C16, 3-p ·
 1 x RCCB, 40A, 0.03A, 4-p

Item No.: ESP14-2
Equipment: 4 x socket · 1 x CEE 5/32A 400V/6h
Fuse: 2 x MCB, B16, 1-p · 1 x MCB, C32, 3-p ·
 1 x RCCB, 40A, 0.03A, 4-p

Connection: 1 x terminal box 2 x 5 x 10 mm²

Parts: BAESP14 ground anchor (page 74)

Material: Stainless steel
Dimensions: Ø 304 x 1131 mm
Base plate: Ø 350 mm
Protection: IP44
Supply line: from below
Color: DB701 or DB703 (RAL-Color possible)
Weight: 36 kg
Feature: Lockable by semi-cylinder. Door can be closed with inserted plugs. The sockets are integrated in the plastic housing, secured with FI/LS and completely wired.

ESP24



Item No.: **Equipment:**
 ESP24-1 1 x CEE 5/32A · 1 x CEE 5/16A · 4 x socket
 ESP24-2 1 x CEE 5/32A · 1 x CEE 5/16A · 8 x socket
 ESP24-3 1 x CEE 5/32A · 1 x CEE 5/16A · 4 x socket ·
 1 x water connection
 ESP24-4 1 x 63A · 1 x CEE 5/32A · 1 x CEE 5/16A · 4 x socket

Fuse: Adapted to the respective equipment

Connection: Adapted to the respective equipment

Parts: BAESP24 ground anchor (page 75)

Material: Stainless steel
Dimensions: Ø 356 x 1145 mm
Base plate: Ø 450 mm
Protection: IP44
Supply line: from below
Color: DB701 or DB703 (RAL-Color possible)
Weight: 43 kg
Feature: Lockable by semi-cylinder. Door can be closed with inserted plugs. The sockets are integrated in the plastic housing, secured with FI/LS and completely wired.



Beispiel RAL-Color



EST12



Item No.:	Equipment:
EST12-1	2 x CEE 3/16A 230V/6h
EST12-2	4 x socket
EST12-3	2 x socket · 1 x CEE 5/16A 400V/6h
EST12-4	2 x socket · 1 x CEE 5/32A 400V/6h
Fuse:	Adapted to the respective equipment
Connection:	Adapted to the respective equipment
Parts:	BAEST12 ground anchor (page 75)
Material:	Stainless steel
Dimensions:	265 x 687 x 205 mm (W x H x D)
Protection:	IP44
Supply line:	1 x below opening
Color:	Stainless steel
Weight:	20 kg
Feature:	Lockable by rotating latch lock. Can be closed with inserted plugs. The sockets are integrated in the plastic housing, protected with FI/LS and completely wired. The housing can be removed like a hood, which simplifies assembly and installation.

EST24



Equipment:	1 x CEE 5/32A · 1 x CEE 5/16A · 4 x socket
Fuse:	2 x MCB, B16, 1-p · 1 x MCB, C16, 3-p · 1 x MCB, C32, 3-p · 1 x RCCB, 40A, 0.03A, 4-p
Connection:	1 x terminal box 2 x 5 x 10 mm ²
Parts:	BAEST24 ground anchor (page 76) 12301 base (page 68)
Material:	Stainless steel
Dimensions:	425 x 1000 x 285 mm (W x H x D)
Protection:	IP44
Supply line:	1 x below 200 x 150 mm
Color:	Stainless steel
Weight:	31 kg
Feature:	Lockable by semi-cylinder. Door can be closed with inserted plugs. The sockets are integrated in the plastic housing, secured with FI/LS and completely wired.



EST25



Item No.:	Equipment:
EST25-1	8 x socket · 2 x CEE 5/16A 400V/6h · 2 x CEE 5/32A 400V/6h
EST25-2	4 x socket · 1 x CEE 5/16A 400V/6h · 1 x CEE 5/32A 400V/6h · 1 x CEE 5/63A 400V/6h
EST25-3	4 x socket · 2 x CEE 5/16A 400V/6h · 2 x CEE 5/32A 400V/6h 1 x CEE 5/63A 400V/6h
Fuse:	Adapted to the respective equipment
Connection:	1 x main line branch clamp Pollmann HLAK 25mm ² , 5pol.
Parts:	BAEST25 ground anchor (page 76) 12301 base (see right)
Material:	Stainless steel
Dimensions:	425 x 1310 x 285 mm (W x H x D)
Protection:	IP44
Supply line:	1 x below, 200 x 150 mm
Color:	Stainless steel
Weight:	41 kg
Feature:	Lockable by semi-cylinder. Door can be closed with inserted plugs. The sockets are integrated in the plastic housing, secured with FI/LS and completely wired.



12301



Parts for:	EST24 and EST25
Item No.:	12301 Base
Material:	Stainless steel
Dimensions:	420 x 271 x 280 mm (W x H x D)
Supply line:	Below and above open
Color:	Stainless steel
Weight:	8,65 kg
Feature:	The base serves as a substructure for the power column and creates space at the connection for e.g. B. rigid and inflexible cables that sit firmly in the concrete.



Ground anchor



BAES102



Item No.:	BAES102	ground anchor
Parts for:	Power column ES102	
Material:	Stainless steel	
Dimensions:	130 x 319 x 110 mm (W x H x D)	
Base plate:	130 x 110 mm (B x D)	
Surface:	Stainless steel untreated	



BAES301



Item No.:	BAES301	ground anchor
Parts for:	Power column ES301	
Material:	Stainless steel	
Dimensions:	Ø 130 x 337 mm	
Base plate:	Ø 130 mm	
Surface:	Stainless steel untreated	



BAES321



Item No.:
BAES321 ground anchor

Parts for: Power column ES321

Material: Stainless steel

Dimensions: Ø 210x564 mm

Base plate: Ø 210 mm

Surface: Stainless steel untreated

Feature: With mounted spirit level for easier leveling of the ground anchor during installation.



BAES323



Item No.:
BAES323 ground anchor

Parts for: Power column ES323 and ES323-EM

Material: Stainless steel

Dimensions: Ø 210x564 mm

Base plate: Ø 210 mm

Surface: Stainless steel untreated

Feature: With mounted spirit level for easier leveling of the ground anchor during installation.



BAES401



Item No.:	BAES401	ground anchor
Parts for:	Power column ES401	
Material:	Stainless steel	
Dimensions:	230 x 693 x 230 mm (W x H x D)	
Base plate:	230 x 230 mm (B x D)	
Surface:	Stainless steel untreated	
Feature:	With mounted spirit level for easier leveling of the ground anchor during installation.	

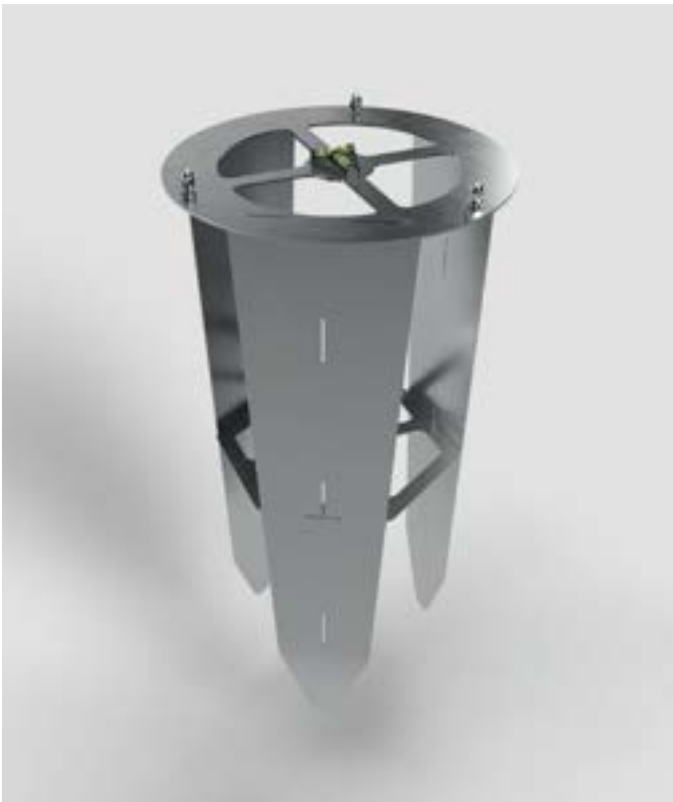

BAESP14

Item No.:	BAESP14	ground anchor
Parts for:	Power column ESP14	
Material:	Stainless steel	
Dimensions:	Ø 355 x 693 mm	
Base plate:	Ø 355 mm	
Surface:	Stainless steel untreated	
Feature:	With mounted spirit level for easier leveling of the ground anchor during installation.	



BAESP24



Item No.: BAESP24 ground anchor

Parts for: Power column ESP24

Material: Stainless steel

Dimensions: Ø 450 x 693 mm

Base plate: Ø 450 mm

Surface: Stainless steel untreated

Feature: With mounted spirit level for easier leveling of the ground anchor during installation.



BAEST12



Item No.: BAEST12 ground anchor

Parts for: Power column EST12

Material: Stainless steel

Dimensions: 260 x 189 x 200 mm (W x H x D)

Base plate: 260 x 200 mm (B x D)

Surface: Stainless steel untreated

Feature: With mounted spirit level for easier leveling of the ground anchor during installation.



BAEST24



Item No.:
BAEST24 ground anchor

Parts for: Power column EST24

Material: Stainless steel

Dimensions: 404 x 693 x 280 mm (W x H x D)

Base plate: 404 x 280 mm (B x D)

Surface: Stainless steel untreated

Feature: With mounted spirit level for easier leveling of the ground anchor during installation.

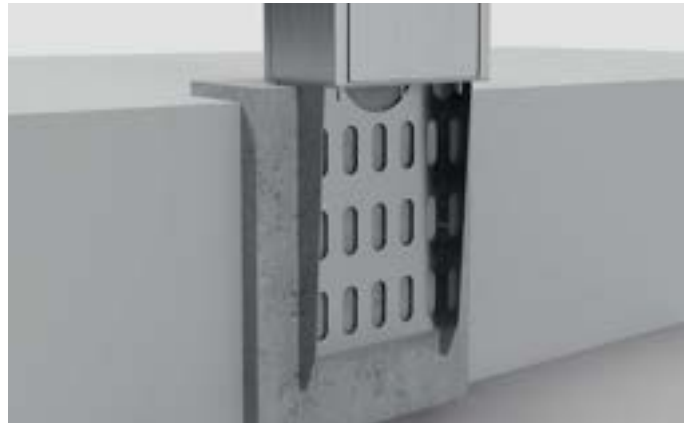

BAEST25



Item No.:
BAEST25 ground anchor

Parts for: Power column EST25

Material: Stainless steel

Dimensions: 404 x 693 x 280 mm (W x H x D)

Base plate: 404 x 280 mm (B x D)

Surface: Stainless steel untreated

Feature: With mounted spirit level for easier leveling of the ground anchor during installation.



Wall sockets Wall distributors



5501A



Item No.: 5501A	Equipment: 1 x socket
Material:	Aluminum, Stainless steel
Dimensions:	86 x 98 x 60 mm (W x H x D)
Instl depth:	51 mm (wall)
Protection:	IP64 (IP44 electr. units)
Supply line:	2 x lateral, 2 x back, 1 x above, 1 x below, each \varnothing 26 mm
Weight:	400 g
Feature:	Lockable by rotating latch lock.

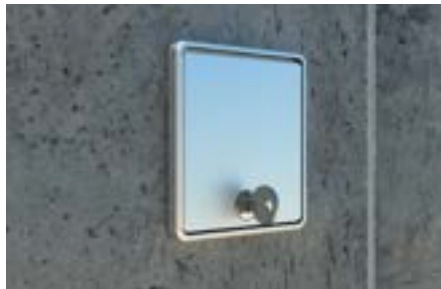

5503A



Item No.: 5503A 5503A1	Equipment: 3 x socket 2 x socket, 1 x RJ45 double
Material:	Aluminum, Stainless steel
Dimensions:	199 x 199 x 83 mm (W x H x D)
Instl depth:	81 mm (wall)
Protection:	IP65 (IP44 electr. units)
Supply line:	2 x lateral, 2 x back, 2 x above, each \varnothing 26 mm
Weight:	2000 g
Feature:	Ideal for sports halls – audited resistance to ball-impacts (DIN 18032 Part 3). Lockable with tools. Can be closed with inserted plugs.

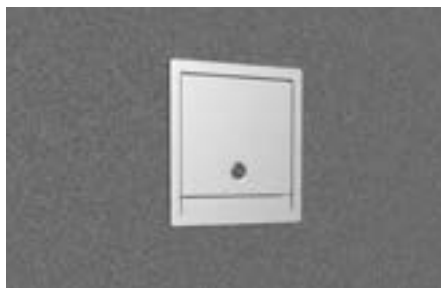



5510E



Item No.:	Equipment:
5510E1	1 x CEE 5/16A 400V/6h
5510E2	1 x CEE 5/32A 400V/6h
<hr/>	
Material:	Stainless steel
Dimensions:	150 x 320 x 130 mm (W x H x D)
Protection:	IP44
Supply line:	Opening on the back 100 x 100 mm
Weight:	3700 g



5511A



Item No.:	Equipment:
5511A	1 x CEE 5/16A 400V/6h · 1x socket
<hr/>	
Material:	Aluminum, Stainless steel
Dimensions:	199 x 350 x 103 mm (W x H x D)
Instl depth:	101 mm (wall)
Protection:	IP65 (IP44 electr. units)
Supply line:	2 x lateral, 2 x back, 2 x below, each \varnothing 26 mm
Weight:	3900 g
Feature:	Ideal for sports halls – audited resistance to ball-impacts (DIN 18032 Part 3). Lockable with tools. Can be closed with inserted plugs.





5523A



Item No.: 5523A
Equipment: 3x socket · 1 x CEE 5/16A 400V/6h ·
 1 x CEE 5/32A 400V/6h

Material: Aluminum, Stainless steel
Dimensions: 400 x 400 x 145 mm (W x H x D)
Instl depth: 143 mm (wall)
Protection: IP44 (electr. units)
Supply line: 2x lateral, 2x back, 2x above, each Ø 26 mm
Weight: 9000 g
Feature: Ideal for sports halls – audited resistance to ball-impacts (DIN 18032 Part 3). Lockable with tools. Can be closed with inserted plugs.



5602E

Item No.: 5602E
Equipment: 2x socket

Material: Stainless steel, Aluminum
Dimensions: 104 x 141 x 93 mm (W x H x D)
Protection: IP21 (electr. units)
Supply line: 1 x above, 1 x back, each Ø 25 mm
Color: Black (RAL 9005), White (RAL9010), DB701, DB703
Weight: 1000 g
Feature: Lockable by rotating latch lock. Can be closed with inserted plugs.





Color DB703

5620E



Item No.:	Equipment:
5620E	1 x CEE 5/16A 400V/6h · 1 x CEE 5/32A 400V/6h
5620E1	1 x CEE 5/16A 400V/6h · 2 x socket

Material:	Stainless steel
Dimensions:	300 x 400 x 217 mm (W x H x D)
Protection:	IP44 (electr. units)
Supply line:	2 x back, 2 x below, each Ø 32 mm
Color:	DB701 or DB703 (RAL-Colorn possible)
Weight:	9500 g
Feature:	The door closes even when standard plugs are inserted and can be locked with a profile half-cylinder lock.



Color DB701



Color DB701



Color DB703



5622E



Equipment:	2 x socket · 1 x CEE 5/16A 400V/6h · 1 x CEE 5/32A 400V/6h
Fuse:	2 x MCB, B16, 1-p · 1 x MCB, C16, 3-p · 1 x MCB, C32, 3-p 1 x RCCB, 40A, 0.03A, 4-p
Material:	Stainless steel
Dimensions:	400 x 500 x 218 mm (W x H x D)
Protection:	IP44 (electr. units)
Supply line:	2 x back, 2 x below, each Ø 32 mm
Color:	DB701 or DB703 (RAL-Color possible)
Weight:	15 kg
Feature:	The door closes even when standard plugs are inserted and can be locked with a profile half-cylinder lock.



5623E



Equipment:	3 x socket · 1 x CEE 5/16A 400V/6h · 1 x CEE 5/32A 400V/6h
Fuse:	3 x MCB, B16, 1-p · 1 x MCB, C16, 3-p · 1 x MCB, C32, 3-p 1 x RCCB, 40A, 0.03A, 4-p
Material:	Stainless steel
Dimensions:	450 x 650 x 232 mm (W x H x D)
Protection:	IP44 (electr. units)
Supply line:	2 x back each Ø 32 mm, 2 x below each Ø 40 mm
Color:	DB701 or DB703 (RAL-Color possible)
Weight:	17 kg
Feature:	The door closes even when standard plugs are inserted and can be locked with a profile half-cylinder lock.

Emergency power feed-in



Color DB703



Color DB701



5623N



Item No.: 5623N1
Equipment: 1 x CEE 5/63A 400V/1h
Connection: 1 x Main line branch clamp Pollmann
 HLAKE 25mm², 5pol.

Item No.: 5623N2
Equipment: 1 x CEE 5/63A 400V/1h · 1 x change-over-switch 4/63A
Connection: 2 x Main line branch clamp Pollmann
 HLAKE 25mm², 5pol.

Material: Stainless steel
Dimensions: 450 x 650 x 232 mm (W x H x D)
Protection: IP44 (electr. units)
Supply line: 2 x back each Ø 32 mm, 2 x below each Ø 40 mm
Color: DB701 or DB703 (RAL-Color possible)
Weight: 17 kg
Feature: The door closes even when standard plugs are inserted and can be locked with a profile half-cylinder lock.

5722E



Equipment: 2 x socket · 1 x CEE 5/16A 400V/6h ·
 1 x CEE 5/32A 400V/6h

Fuse: 2 x MCB, B16, 1-p · 1 x MCB, C16, 3-p · 1 x MCB, C32, 3-p
 1 x RCCB, 40A, 0.03A, 4-p

Material: Stainless steel
Dimensions: 346 x 496 x 178 mm (W x H x D)
Instl depth: 170 mm (wall)
Protection: IP44 (electr. units)
Supply line: 2 x back, 2 x above, each 1 x Ø 33 mm und 1 x Ø 41 mm
Color: DB701 or DB703 (RAL-Color possible)
Weight: 10,5 kg
Feature: The door closes even when standard plugs are inserted and can be locked with a profile half-cylinder lock.



5723E



Equipment:	3 x socket • 1 x CEE 5/16A 400V/6h • 1 x CEE 5/32A 400V/6h
Fuse:	3 x MCB, B16, 1-p • 1 x MCB, C16, 3-p • 1 x MCB, C32, 3-p 1 x RCCB, 40A, 0.03A, 4-p
Material:	Stainless steel
Dimensions:	446 x 646 x 208 mm (W x H x D)
Instl depth:	200 mm (wall)
Protection:	IP44 (electr. units)
Supply line:	2 x back, 2 x above, each 1 x Ø 33 mm und 1 x Ø 41 mm
Color:	DB701 or DB703 (RAL-Color possible)
Weight:	17 kg
Feature:	The door closes even when standard plugs are inserted and can be locked with a profile half-cylinder lock.

5723N1



Equipment:	1 x CEE 5/63A 400V/1h
Connection:	1 x Main line branch clamp Pollmann HLAK 25mm ² , 5pol.
Material:	Stainless steel
Dimensions:	446 x 646 x 208 mm (W x H x D)
Instl depth:	200 mm (wall)
Protection:	IP44 (electr. units)
Supply line:	2 x back, 2 x above, each 1 x Ø 33 mm und 1 x Ø 41 mm
Color:	DB701 or DB703 (RAL-Color possible)
Weight:	17 kg
Feature:	The door closes even when standard plugs are inserted and can be locked with a profile half-cylinder lock.



Desk power strip



3202E

Item No.:	Equipment:
3202E	2 x socket
3202E1	1 x socket, 1 x RJ45 double
3202E2	1 x socket, 1 x aerial
3202E3	1 x socket, 1 x USB double charge

Material:	Stainless steel (1.4301)
Dimensions:	180 x 83 x 154 mm (W x H x D)
Instl depth:	81,5 mm (desk)
Protection:	IP20
Load:	Area load max. 120 kg
Supply line:	2 x lateral, 2 x back, 2 x below, each \varnothing 26 mm
Feature:	Can be closed with inserted plugs.



3203E

Item No.:	Equipment:
3203E	3 x socket
3203E1	2 x socket, 1 x RJ45 double
3203E2	2 x socket, 1 x aerial
3203E3	2 x socket, 1 x USB double charge

Material:	Stainless steel (1.4301)
Dimensions:	230 x 83 x 153 mm (W x H x D)
Instl depth:	81,5 mm (desk)
Protection:	IP20
Load:	Area load max. 120 kg
Supply line:	2 x lateral, 2 x back, 2 x below, each \varnothing 26 mm
Feature:	Can be closed with inserted plugs.





4204

Item No.:	Equipment:
4204A1 (alu)	4 x socket
4204A2	3 x socket, 1 x USB charge A/C double
4204W1 (white)	4 x socket
4204W2	3 x socket, 1 x USB charge A/C double
4204S1 (black)	4 x socket
4204S2	3 x socket, 1 x USB charge A/C double

Parts: screw clamp set 12271 (see below)

Material:	Aluminum
Dimensions:	191 x 70 x 76 mm (W x H x D)
Protection:	IP20
Color:	Natural anodized aluminium, white (RAL9010), black (9005)
Supply line:	Rear connection (cable length 3 m)



12271

Item No.:	
12271	screw clamp set

Parts for: 4204 desk power strip

Material:	Stainless steel, plastic
Dimensions:	185 x 116 x 49 mm (W x H x D)
Locking range:	up to 30 mm
Surface:	Stainless steel untreated

GTC

General Terms and Conditions of sale and delivery of BS Bodensteckdosen Systemtechnik GmbH

I. PRELIMINARY REMARK

1. Area of application

The deliveries, services and offers of BS Bodensteckdosen Systemtechnik GmbH (hereinafter „BS“, „we“, „us“) are made exclusively on the basis of these General Terms and Conditions of Sale and Delivery (hereinafter „GTC“).

These are part of all contracts that we conclude with our customers (hereinafter „customer“, „you“) about the goods we offer.

2. Customer group

2.1 Our product range is aimed at both consumers and entrepreneurs.

2.2 For the purposes of these Terms and Conditions, (i) a "consumer" is any natural person who concludes a legal transaction for purposes which are predominantly neither commercial nor self-employed (§ 13 BGB) and (ii) an "entrepreneur" is a natural or legal person or a legal partnership that, in concluding a legal transaction, acts in the exercise of its commercial or independent professional activity (§ 14 BGB).

3. Structure

3.1 In the following section "II General Conditions", are those conditions listed which apply in particular to consumers.

For entrepreneurs, they also apply, unless it is explicitly stated that the scope is limited to consumers.

3.2 In the section "III. Special Conditions "are other conditions listed that apply to business owners only.

II. GENERAL CONDITIONS

1. Contract language

The language available for the contract is German.

2. Contract partner

The contract is concluded with BS Bodensteckdosen Systemtechnik.

3. Offer and conclusion of contract

3.1 The offers and prices contained on our website under the domain floor.socketn.com, in brochures, advertisements and other advertising material are non-binding.

3.2 If the customer places an order with us, this constitutes a binding offer to conclude a contract within the meaning of § 145 BGB.

The customer is bound by his declaration 10 calendar days after delivery or by order in text form (e.g. by post / fax / e-mail) from the date of dispatch.

We are entitled to accept the offer within this period.

Decisive for the observance of the period is the time, in which our assumption goes to the customer. Acceptance is also the delivery of the ordered goods.

3.3 As an alternative to the direct order from the customer, we will gladly provide you with a binding offer in writing (i.S.d. § 145 BGB).

We are bound to this 14 calendar days from dispatch.

The customer is entitled to accept our offer within this period. Decisive for compliance with the deadline is the time of receipt of the acceptance by us. Acceptance is also the payment.

4. Right of withdrawal for Consumers

4.1 Every customer who is a consumer is entitled to the statutory right of withdrawal.

Details can be extracted of the cancellation policy, which is printed in our catalog according to these terms and conditions and also on our website under floor.socketn.com and there can be found under the link „Withdrawal“.

4.2 The above said under no. 4.1 does not apply to consumers who conclude a contract with us in our business premises (Dingerdisser Str. 36, 33699 Bielefeld) or make a corresponding offer to us. There is no right of withdrawal for these.

The right of withdrawal also does not apply to the following contracts:

- Contracts for the supply of goods that are not prefabricated and of which for the manufacture an individual selection or provision by the consumer is authoritative or which are clearly tailored to the personal needs of the consumer,

- Contracts for the supply of goods, if, due to their character, they were inseparably mixed with other goods after delivery.

5. Return costs upon revocation

In the case that the customer is a consumer and revokes the contract in the context of his legal right of withdrawal, it is agreed that he has to bear the direct costs of returning the goods.

6. Provider identification, summonable address

Our contact details for complaints and other declarations of intent as well as our address are:

BS Bodensteckdosen Systemtechnik GmbH
Dingerdisser Str. 36
33699 Bielefeld
Germany
represented by business executive Viktor Sperle

Telephone: +49 521 9892780
Telefax: +49 521 989278-30

E-mail: info@bodensteckdosen.com

Register court: Amtsgericht Bielefeld
Register number: HRB40648

Sales tax identification number: DE282391374

7. Prices, shipping costs

7.1 Our prices include the statutory sales tax.

7.2 Shipping is at the expense of the customer.

Regardless of the order value, we charge a flat rate of € 9.00 per order for standard shipping within Germany. For express shipping within Germany, we charge a flat rate of € 40.00 per order, regardless of the order value.

For standard delivery within the EU (except Germany), we charge a flat rate of € 40.00 per order, regardless of the order value. Express shipping to other EU countries is not possible.

8. Payment

Payment is by bank transfer, PayPal or when you buy in our offices in cash.

Payment in advance by bank transfer

When selecting the payment method „bank Transfer“ we will give you our bank details in our offer / order confirmation. There are no additional costs for the customer except for any transaction fees incurred by the customer's bank.

Payment in advance by PayPal

If you select the payment method „PayPal“, we will give you an e-mail address in our offer / order confirmation, which you can use to pay via the aforementioned online provider. In order to be able to use this payment method, the customer must already be registered with PayPal or register first, legitimize himself with his access data and confirm the payment order to us (except, if applicable, guest access).

Technical personnel, drivers and sales force service staff are not eligible for collection.

9. Shipment, Collection

Delivery is only within the EU.

Unless otherwise expressly agreed, we will determine the appropriate shipping method and carrier at our discretion.

In reasonable extent for the customer, we are entitled to partial deliveries. Additional shipping costs are not incurred by the customer through partial deliveries.

In the event of non-availability of the ordered goods due to late or incorrect delivery (including the delivery of small quantities) by our (pre-) supplier in spite of a delivery contract concluded by us with the (pre-) supplier of the ordered goods we reserve the right to not deliver. In this case, we undertake to inform the customer immediately about the unavailability of the ordered goods and to immediately refund any payments already received from the customer.

Delivery takes place within the delivery period specified for the respective product.

The delivery period starts on the day of receipt of the full purchase price (including sales tax and shipping costs).

Delivery is only at ground level and only up to the first door to the address specified by the customer.

If we fail to meet an agreed delivery date, the buyer must set us a reasonable period of grace, which must not be less than one week.

You have the option of picking up at BS Bodensteckdosen Systemtechnik GmbH, Dingerdisser Str. 36, 33699 Bielefeld, Germany for the following business hours:

Mo–Th: 08:00 am – 04:00 pm
Fr: 08:00 am – 02:00 pm

10. Rights in case of material defects

If the customer is a consumer, all goods sold by us are entitled to statutory warranty claims in the event of material defects.

11. Retention of title

The delivered goods remain our property until their complete payment.

12. Privacy

We collect and store the data of the customer necessary for the transaction. When processing the personal data of the customer, we observe the legal provisions. Further details can be found in our „Privacy Policy“, which you will find under the link of the same name on our homepage at floor.socketn.com

13. Sending the contract terms

We provide the customer, who is consumer, at the latest with delivery of the goods, the contract terms including these terms and conditions in writing.

14. Further regulations, dispute resolution

- 14.1 Should one or more provisions of these General Terms and Conditions be invalid, the remainder of the contract remains valid. The ineffective regulation is replaced by the legal regulation.
- 14.2 German law applies excluding the UN sales law (CISG). This choice of law applies only to the extent that this does not withdraw mandatory applicable Consumer protection laws of the state in which the consumer is habitually resident at the time of the order.
- 14.3 The European Commission provides a platform for online dispute resolution (OS), which can be found at the following link: <http://ec.europa.eu/consumers/odr/>. We are not obligated and unwilling to participate in a dispute settlement procedure before a consumer arbitration board.

III. SPECIAL CONDITIONS

1. Future business, Customer-GTC

- 1.1 For customers who are entrepreneurs, these GTC also apply to future business, even if we do not point this out again in the future.
- 1.2 Terms and conditions of the customer do not apply, even if we do not separately contradict their validity in individual cases. Even if we refer to a letter that contains or refers to terms and conditions of the customer or a third party, this does not constitute acceptance of the validity of these terms and conditions.

2. Offer and Conclusion of contract

The statements made in II. 3. regarding the offer and conclusion of the contract also apply to business customers, but with the following provisos:

- 2.1 The sole decisive factor for the legal relationship between us and the customer is the written purchase contract, including these GTC. This completely reproduces all agreements between the contracting parties regarding the subeacht matter of the contract. Verbal commitments by BS before conclusion of the contract are legally non-binding and verbal agreements of the contracting parties are replaced by the written contract, unless it is expressly clear from them that they continue to be binding.
- 2.2 Information provided by BS on the subeacht matter of the delivery / service (eg weights, dimensions, utility values, load capacity, tolerances and technical data) as well as our representations of the same (eg drawings and illustrations) are only approximate unless the usability for the contractually provided purpose presupposes an exact match. They are not guaranteed characteristics, but descriptions or labeling of the delivery / service. Customary deviations and deviations, which occur due to legal regulations or represent technical improvements, as well as the replacement of components by equivalent parts are permissible, as far as they do not affect the usability for the contractually intended purpose.
- 2.3 BS reserves the ownership / copyright of all offers and estimates submitted by it, as well as any drawings, illustrations, calculations, brochures, catalogs, models, tools and other documents and aids provided to the customer. The customer may not make these obeachts accessible to third parties without the express consent of BS, as such, or in terms of content, notify them, or use or duplicate them themselves or through third parties. He shall, at the request of BS, return these items in full and destroy any copies made if they are no longer required by him in the ordinary course of business or if negotiations do not lead to the conclusion of a contract. Excluded from this is the storage of electronically provided data for the purpose of conventional data backup.

3. Prices, Price changes

The comments made under II. 7 on prices also apply to business customers, but with the following stipulations / changes:

- 3.1 By way of derogation from II.7.1, in the case of tenders and written offers, net prices are given which are understood to be exclusive of statutory value added tax.
- 3.2 Insofar as the agreed prices are based on the list prices of BS and delivery should take place more than four months after the conclusion of the contract, the list prices of BS valid on delivery shall apply.

4. Payment and delay

The comments made under II. 8 on payment options also apply to business customers, but with the following stipulations / changes / additions:

In addition to those in II.8. business customers can also pay by invoice. The invoice amounts are payable within twenty-one days without any deductions, unless otherwise expressly agreed. Decisive for the date of payment is receipt by us. Payment by check is excluded unless it is agreed separately in individual cases.

If the customer does not pay by the due date, the outstanding amounts shall be subeacht to interest at a rate of 9 percentage points above the base rate from the due date; the assertion of higher interest and further damages in case of default remains unaffected.

5. Set-off and right of retention

- 5.1 The offsetting of counterclaims of the customer or the retention of payments due to such claims is only permitted if the counterclaims are undisputed or legally binding.
- 5.2 BS shall be entitled to execute or render outstanding deliveries or services only against advance payment or provision of security if, after the conclusion of the contract, it becomes aware of circumstances which are capable of substantially reducing the creditworthiness of the customer and by which the payment of BS's outstanding claims of the customer from the respective contractual relationship (including from other individual orders to which the same framework contract applies) is endangered.

6. Shipping, Collection, Place of fulfillment, passing of risk, Approval

By way of derogation from, or supplementary to II. 9., the following applies to business customers with regard to shipping and collection as well as (additionally) with regard to the place of fulfillment, transfer of risk and approval:

- 6.1 Place of fulfillment for all obligations arising from the contractual relationship are our business premises, unless otherwise specified. We reserve the right to deliver goods from other locations (third-party shops). In these cases, the respective location from which the delivery takes place is the place of fulfillment.
- 6.2 The risk shall pass to the customer at the latest upon the handover of the delivery item (whereby the beginning of the loading process is decisive) to the forwarder, carrier or other third party designated for the execution of the shipment. This also applies if partial deliveries are made or BS has taken on other services (such as shipping). If the shipment or transfer is delayed as a result of a made of whose made of lies with the customer, the risk passes to the customer from the day on which the delivery item is ready for despatch and BS has notified the customer.
- 6.3 Storage costs after transfer of risk shall be borne by the customer. In the case of storage by BS, the storage costs amount to 0.25 percent of the invoice amount of the delivery items to be stored per completed week. The assertion and proof of further or lower storage costs remains reserved.
- 6.4 Deadlines and dates for deliveries and services provided by BS are only approximate, unless a fixed deadline or a fixed date has been expressly confirmed or agreed. If shipment has been agreed, delivery periods and delivery dates refer to the time of transfer to the forwarder, carrier or other third party commissioned with the transport.
- 6.5 Without prejudice to its rights arising from default by the customer, BS may require the customer to extend delivery and service periods or postpone delivery and service deadlines by the period in which the customer fails to meet its contractual obligations towards BS.
- 6.6 BS shall not be liable for impossibility of delivery or for delays in delivery, as far as these are due to force majeure or other unforeseeable events at the time of the conclusion of the contract (eg breakdowns of all kinds, difficulties in material or energy procurement, delays in transport, strikes, legitimate lockouts, lack of manpower, Energy or raw materials, difficulties in obtaining necessary regulatory approvals, regulatory action or the lack of, incorrect or untimely supplier delivery) that BS is not responsible for. If such events make the delivery or service substantially more difficult or impossible and the hindrance is not only temporary, BS is entitled to withdraw from the contract. In the case of obstacles of a temporary duration, the delivery or service periods shall be extended or the delivery or service dates shall be postponed by the period of the hindrance plus a reasonable start-up period. Insofar as the customer can not reasonably be expected to accept the delivery or service as a result of the delay, he can withdraw from the contract by means of an immediate, written declaration to BS.
- 6.7 In reasonable extent for the customer, we are entitled to partial deliveries. Additional shipping costs are not incurred by the customer through partial deliveries.
- 6.8 If BS is in default with a delivery or service or if it becomes impossible for it to deliver or perform any service for whatever reason, BS's liability for damages is limited in accordance with III. 7.
- 6.9 We will insure the shipment against theft, breakage, transport, fire and water damage or other insurable risks only at the express request of the customer and at his expense.

- 6.10 Insofar as acceptance has to take place, the purchased item shall be deemed accepted if

- the delivery and, if BS also owes the setting up / installation, the setting up / installation is completed,
 - BS informed the customer with reference to the acceptance fiction according to this III. 6.10 and has asked him to accept,
 - 12 working days have passed since the delivery or setting up / installation or the customer has started to use the purchased goods and in this case six working days have elapsed since delivery or installation
- and
- the customer refrained from accepting the goods within this period for any reason other than a defect indicated to us which makes the use of the goods impossible or substantially impaired.

7. Liability

Differing from II. 10., the following applies to liability for business customers under the express application for merchants of § 377 HGB:

- 7.1 We are also liable for damages to customers who are entrepreneurs, according to the legal provisions without limitation, if these
- a. are based on injury to life, body or health and have been caused by a willful or negligent breach of duty by us, our legal representatives or vicarious agents,
 - or
 - b. based on an intentional or grossly negligent breach of duty by us, our legal representatives or vicarious agents
 - or
 - c. based on the product liability law
 - or
 - d. We have assumed a procurement risk or a guarantee and are therefore liable.
- 7.2 Is a loss based only on negligent but not grossly negligent breach of a contractual obligation (cardinal obligation) by us, our legal representatives or vicarious agents, without at the same time a claim based on the above provisions to a. to d. we are also liable for damages, but limited in amount to Typical and foreseeable damage.
- Essential contractual obligations (cardinal obligations) in the above sense are those obligations whose proper fulfillment the customer trusts and may trust, because they shape the contract.
- 7.3 In addition, we are liable, as far as claims for damages are covered by a liability insurance.
- 7.4 It remains with the legal burden of proof distribution.
- 7.5 Further claims for damages against us, our legal representatives or vicarious agents are excluded, no matter on what legal grounds they are based.

8. Statute of limitation of material defects

- 8.1 Rights and claims of customers who are entrepreneurs become statute-barred in one year, unless
- a. the delivered goods are a thing that has been used for a building in accordance with its normal use and has caused its defectiveness
 - or
 - b. these are reimbursement claims according to § 479 BGB
 - or
 - c. the defect is based on an intentional breach of duty by us, our legal representatives or vicarious agents
 - or
 - d. these are claims for damages.
- In cases a. to d. the statutory limitation periods apply.
- 8.2 It remains with the legal provisions on the inhibition, expiry and on the new beginning of the statute of limitations.

9. Retention of title

Differing the provision in II. 11., to customers who are entrepreneurs the following retention of title applies:

- 9.1 We reserve ownership of all delivered goods (goods subeachct to retention of title) until full payment of the purchase price and until such time as all our claims from the business relationship have been paid.
- 9.2 The customer is entitled to process the goods in the ordinary course of business and to resell them, as long as he is not in default with the fulfillment of his obligation towards us or stops his payments. Specifically, the following applies:

- a. The processing or transformation of the reserved goods takes place for us within the meaning of § 950 BGB, without obliging us. By processing or transformation of the reserved goods, the customer does not acquire the property in accordance with § 950 BGB on the new thing.

If the reserved goods are processed, mixed, blended or combined with other oeachcts, we acquire co-ownership of the new item at a share that corresponds to the ratio of the invoice value of our reserved goods to the total value.

The provisions applicable to the goods subeachct to retention of title shall apply mutatis mutandis to the co-ownership shares arising under the above provisions.

- b. The customer herewith assigns the receivables from the resale or the other sales transactions, such as Contracts with all ancillary rights to us from and proportionately also in so far as the goods are processed, mixed or blended and we have acquired hereby in the amount of our invoice value co-ownership or the product is permanently installed. Insofar as the reserved goods are processed, mixed, blended or permanently installed, we are entitled to a fraction of the respective claim from the resale in proportion to the invoice value of our reserved goods to the invoice value of the oeachct.

If the reserved goods are sold by the customer together with other goods not supplied by us, the customer hereby assigns to us a portion of the claim from the resale in the amount of the invoice value of our reserved goods.

If the customer has sold this claim in the context of genuine factoring, he hereby assigns to us the claim against the factor which will take its place. If the claim from the resale by the customer into a current account relationship with his customer, he assigns his claim from the current account relationship hereby amounting to the invoice value of the goods subeachct to retention.

- c. We hereby accept the above assignments.
- d. The customer is entitled until the revocation by us to collect the claims assigned to him. The collection authorization expires on revocation, which takes place if the customer is in default of payment or stops the payment. In this case we are authorized by the customer to inform the customers of the assignment and to collect the claim ourselves.

The customer is obliged to give us on request a detailed list of his claims with the name and address of the customer, amount of each claim, date of invoice, etc. and give us all information and documents necessary for the assertion of the assigned claims and the review to allow this information.

- e. Amounts received from assigned claims by the customer are to be set aside for us until the transfer to us.
- f. Pledges or assignments of security of the reserved goods or the assigned claims are inadmissible. We are to be informed immediately of seizures, stating the seizure creditor.
- 9.3 If the value of the securities to which we are entitled exceeds our total claim against the customer by more than 10%, we shall be obliged to release it at the customer's request.
- 9.4 The customer stores the reserved goods for us free of charge. The customer must insure them against usual dangers such as fire, theft and water to the usual extent. The customer hereby assigns to us his claims for compensation which he is entitled to from damages of the Typee mentioned against insurance companies or other persons liable for compensation in the amount of his claim. We accept the assignment.

10. Return of goods

- 10.1 Our consent must be obtained before returning any goods.
- 10.2 As a matter of principle, we do not assume any return costs. Goods returned freight collect will not be accepted.
- 10.2 If the goods are returned within 3 months from the date of delivery, we charge 15% return costs, within 4-12 months we charge 30% return costs. After 12 months a return is excluded. Furthermore, BS reserves the right to exclude items removed from the product range from return after 6 months.
- 10.3 Order cancellations are not permitted. We reserve the right to refuse cancellation requests or to charge a flat cancellation fee of 50€. If the goods are already ready for dispatch, we reserve the right to charge a cancellation fee of 15% of the value of the goods.
- 10.4 Returned goods must be in their original packaging and in a proper and saleable condition. Dirty, damaged, or incomplete goods will not be taken back. Custom-made products and special designs are excluded from exchange or return. Returns with a net goods value of less than EUR 50 will not be refunded.

11. Place of jurisdiction

- 11.1 The place of jurisdiction is located at our registered office, provided that the entrepreneur's business is a merchant or the other requirements of a jurisdiction agreement according to § 38 ZPO are met.
- 11.2 We are always entitled to use the business customer at his general place of jurisdiction.

12. Proper law

With respect to customers who are entrepreneurs, German law always applies to the contractual relationship, as it does under two contractual partners domiciled in Germany, to the exclusion of the UN Sales Convention (CISG).

Right of Cancellation for Consumers

CANCELLATION POLICY

Right of Cancellation

You have the right to withdraw from this contract within fourteen days without giving any reason.

The revocation period is fourteen days from the day on which you or a third party named by you, who is not the carrier, had or has taken possession of the last goods.

In order to exercise your right of revocation, you must inform us (BS Bodensteckdosen Systemtechnik GmbH, Dingerdisser Str. 36, 33699 Bielefeld, phone: 0521 9892780, fax: 0521 989278-30, E-Mail: info@bodensteckdosen.com) by means of a clear statement (eg one with the post sent letter, fax or e-mail) about your decision to withdraw from this contract.

In order to maintain the cancellation period, it is sufficient for you to send the notification of the exercise of the right of withdrawal before the expiry of the withdrawal period.

Consequences of the cancellation

If you withdraw from this Agreement, we have to repay all payments we have received from you, including delivery charges (except for the additional costs arising from choosing a different delivery method than the most favorable standard delivery we offer) immediately and at the latest within fourteen days from the date on which the notification of your revocation of this contract has reached us. For this repayment, we will use the same means of payment as you used in the original transaction, unless expressly agreed otherwise with you; In no case you will be charged for this repayment fees. We may refuse repayment until we have received the goods back or until you have provided proof that you have returned the goods, whichever is the earlier.

You must return the goods to us immediately and in any event not later than fourteen days from the date on which you inform us of the cancellation of this contract. The deadline is met if you send the goods before the deadline of fourteen days. You bear the immediate costs of returning the goods. You only have to pay for a possible loss in value of the goods, if this loss of value is due to a handling that is not necessary for the examination of the nature, characteristics and functioning of the goods.

End of revocation

The right of withdrawal does not apply to the following contracts:

- Contracts for the supply of goods which are not prefabricated and for the manufacture of which an individual selection or determination by the consumer is decisive or which are clearly tailored to the personal needs of the consumer,
- Contracts for the supply of goods, if, due to their nature, they were inseparably mixed with other goods after delivery.

INDEX

1206	6	7601A	35	8908HB	49
12201	27	7602A	35	8912B	27
12202	28	7701AW	36	8920B	28
12203	29	7702A	36	9901A	29
12210	37	7704A	37	9902A	30
12251	38	7705A	56	9902B	30
12255	38	8302A	13	9902D	31
12256	39	8308A	14	9904A	31
12271	87	8310A	56	9908A	49
12301	70	8314A	57	BAES102	72
2003A	6	8501B	42	BAES301	72
2003B	7	8501E	42	BAES321	73
2003Q	7	8502B	43	BAES323	73
2004A	8	8502E	43	BAES401	74
2004B	8	8504B	44	BAESP14	74
2004Q	9	8504E	44	BAESP24	75
2008A	9	8508B	45	BAEST12	75
2008B	10	8508E	45	BAEST24	76
2008Q	10	8512B	46	BAEST25	76
3202E	11	8601A	14	ES102	64
3203E	11	8602A	15	ES301	64
3301E	12	8604A	15	ES321	65
3302E	12	8701A	16	ES323	65
3303E	13	8702A	16	ES323-EM	66
3202E	86	8802A	17	ES401	66
3203E	86	8802B	17	ES882	67
4204	87	8802E	18	ES884	67
5501A	78	8802T	18	ESP14	68
5503A	78	8804B	19	ESP24	68
5510E	79	8804E	19	EST12	69
5511A	79	8804T	20	EST24	69
5523A	80	8808A	20	EST25	70
5602E	80	8808B	21	SV111	60
5620E	81	8808E	21	SV112	60
5622E	82	8808T	22	SV301	61
5623E	82	8810B	22	SV302	61
5623N	83	8900B	23	SV501	62
5722E	83	8901B	23		
5723E	84	8902B	24		
5723N1	84	8902BB	24		
6522A	52	8902H	46		
6523Q	52	8902HB	47		
6610A	53	8904B	25		
6620A	53	8904BB	25		
6710A	54	8904H	47		
7002A	34	8904HB	48		
7012A63	55	8908B	26		
7022A	55	8908BB	26		
7501A	34	8908H	48		



floor socket 8601A



retractable power distributors SV302



floor socket 8804B





**BODENSTECKDOSEN
SYSTEMTECHNIK**



Raised floor trunking system | Coming soon.

Floor tank with raised floor trunking system.



bs BODENSTECKDOSEN
SYSTEMTECHNIK